

Garlock Sealing Technologies®

KLOZURE® Oil Seals & Bearing Isolators

Seal in your profits™

TECHNICAL MANUAL

The Rotating Equipment Authority™



Garlock

SEALING TECHNOLOGIES®

ООО «ТИ-СИСТЕМС» ИНЖИНИРИНГ И ПОСТАВКА ТЕХНОЛОГИЧЕСКОГО ОБОРУДОВАНИЯ
Интернет: www.tisys.ru www.tisys.kz www.tisys.by www.tesec.ru www.ти-системс.пф
Телефоны: +7 (495) 7774788, 7489626, (925) 5007155, 54, 65 Эл. почта: info@tisys.ru info@tisys.kz info@tisys.by

Foreword

We believe in the principle that you can't be all things to all people. Garlock has chosen to be the leading *manufacturer* of radial lip seals and bearing protection devices servicing the industrial marketplace. We believe the best method to get our products to the industrial customer is through strategic alliances with our distribution partners. Our commitment to our distributors, and the ultimate user, is to constantly introduce

new and innovative products at higher levels of quality with an emphasis on compressed lead times - products that will last longer and reduce overall maintenance costs. All of our employees have a "can do" attitude and take pride in helping customers. You have a problem? We have a solution. All we ask is the chance to prove ourselves; you won't be disappointed!

Garlock Warranty

All merchandise ordered shall be sold subject to SELLER'S standard warranty, viz: SELLER warrants that any product of its manufacture, which upon examination is found by a SELLER'S representative to be defective either in workmanship or material whereby it is not suitable under proper usage and service for the purpose for which designed, will be, at SELLER'S option, repaired or replaced free of charge including transportation charges but not cost of installation providing

that SELLER receives written claim specifying the defect within one year after SELLER ships the product. ALL OTHER WARRANTIES EXPRESSED OR IMPLIED INCLUDING ANY WARRANTY OF MERCHANTABILITY ARE HEREBY DISCLAIMED. The foregoing expresses all of SELLER'S obligations and liabilities with respect to the quality of items furnished by it and it shall under no circumstances be liable for consequential damages.

General Seal Selection

Single Lip Seals are ideal for the majority of sealing applications. These general purpose seals are available in a wide range of stock sizes.

Split KLOZURE® Oil Seals and Bearing Isolators are designed for easy installation on large shafts without costly teardown for seal replacement.

Dual Lip Oil Seals are recommended for those applications involving the separation of two fluids, the exclusion of abrasive or foreign materials, and difficult or unusual sealing problems.

Bonded Oil Seals are used in applications where low cost and minimum performance are the primary considerations.

Special Purpose Oil Seals are recommended for high speed applications, reciprocating service, spherical bearings, tapered roller bearings and similar applications.

ISO-GARD® and EQUALIZER® Bearing Isolator Seals provide superior bearing protection where outstanding contaminant exclusion and ultra long life are desired.

MICRO-TEC® Bearing Protector Seals combine a unique design and microcellular technology, for rotating or stationary shaft sealing and bearing protection in highly contaminated environments.

The Garlock line of KLOZURE® Oil Seals and Bearing Isolators is asbestos-free.

We are pleased to present this Garlock KLOZURE® Oil Seals and Bearing Isolators catalog. It contains the most concise, current sealing information to make seal selection easy and accurate, providing reference to applications, shaft speeds, operating temperatures and shaft size. This information permits you to select a Garlock KLOZURE® Oil Seal for long-lasting, trouble-free service.

For online selection, visit the Garlock network at www.garlock.net

For non-standard applications, contact Garlock to complete a detailed application data sheet.

How to use the KLOZURE® Oil Seal Master Catalog

Our family of Garlock KLOZURE® Oil Seal and Bearing Isolators catalogs is designed to make ordering Garlock KLOZURE® Oil Seals as easy as possible and to give you the most complete information on oil seals you will find anywhere.

This catalog is organized by the type of seal you need with sections for Single Lip, Dual Lip and Special Purpose seals. Pertinent information on each model is summarized in these sections so that you may choose an oil seal directly from the information shown here.

The general engineering section is designed to offer guidance concerning shaft finish, misalignment, pressure data, tolerance charts and technical specifications... all the information that will help you seal effectively. The selection chart for seal elements lets you compare temperature, fluid compatibility, relative cost, service life... everything that you need to choose the right seal for your application.

Installation instructions with diagrams have also been included, along with a troubleshooting tips section, to help you solve possible problems.

Index

Page

Single Lip KLOZURE® Oil Seals

Spring Loaded: Models 26, 53, 59, 63, 64, 66, 67, 76, 87, 88, 92	2, 3
No Spring: Models 58, 71, 91	.4

Dual Lip KLOZURE® Oil Seals

Dual Opposed (both lips with spring): Models 53R2, 63R2	.5
Dual Opposed (one lip with spring): Models 3, 26R1, 53R1, 53F1, 57, 94	.6
Dual Tandem (front lip, no spring): Models 53TB, 63TB	.7
Dual Tandem (both lips with spring): Models 53T2, 63T2	.7

Single Lip Split KLOZURE® Oil Seals

Models 21, 23, 24, 25, 26	.8
---------------------------	----

External Lip Seals

Models 111, 113, 123	.9
----------------------	----

Special Purpose KLOZURE® Oil Seals

Model 54: Seals for Spherical Bearings	.10, 11
Model 61, 62: PTFE Seal	.10
Model 142: Steel Mill Water Seals	.10, 11
Model 145A-1, 145A-2: Face-Type Excluder Seals	.10, 11
MICRO-TEC® Bearing Protector Seals	.12
EQUALIZER® Bearing Protector Seals	.12
ISOGARD® Bearing Isolator Seals	.13

Engineering and Installation Information

General Engineering Data	.14
General Engineering Data Tables	.14 - 17
Nomenclature	.18
Selection Charts for Seal Elements	.19
Assembled and Bonded Seals	
Installation Instructions	.20 - 22
Split KLOZURE® Oil Seals, Models 21, 23, 24, 25, 26	
Application Information and Size Guide	.23
Conversion Instructions	.24
Installation Instructions	.25
Troubleshooting	.26
Typical KLOZURE® Oil Seal Configurations	.27
Model number to Part number Conversion	.28

Relationship Between RPM, FPM and Shaft DiametersInside Back Cover

How to OrderBack Cover

Single Lip - Spring Loaded General Purpose Lubricant Retention Seals

	Features	Shaft Diameters In. (MM)	Surface Speed FPM (MPS)	Misalignment & Runout In. @ FPM (MM @ MPS)	Spring	O.D. Construction
MODEL 26 	<ul style="list-style-type: none"> General purpose, non-metallic seal Molded one-piece construction 	3/4 thru 60 (19.4 thru 1524)	5000 (25.4)	0.015 @ 1000 (0.38 @ 5.1) 0.010 @ 2000 (0.25 @ 10.2) 0.008 @ 5000 (0.20 @ 25.4)	Stainless Steel Finger	Rubber with reinforced heel
MODEL 53 	<ul style="list-style-type: none"> Heavy duty case General purpose standard seal Assembled design 	3 thru 90 (76.2 thru 2286)	3000 (15.2)	0.015 @ 1000 (0.38 @ 5.1) 0.10 @ 2000 (0.25 @ 10.2) 0.005 @ 3000 (0.13 @ 15.2)	Stainless Steel Finger	Steel Case**
MODEL 59 	<ul style="list-style-type: none"> Moderate to severe operating conditions Heavy duty metal case Assembled design 	6 thru 90 (152.4 thru 2286)	5000 (25.4)	0.093 Max. (2.36)	Stainless Steel Finger	Steel Case**
MODEL 63 	<ul style="list-style-type: none"> Equivalent to Model 53 Assembled design 	1/4 thru 3 (6.4 thru 76.2)	3000 (15.2)	0.015 @ 1000 (0.38 @ 5.1) 0.010 @ 2000 (0.25 @ 10.2) 0.005 @ 3000 (0.13 @ 15.2)	Stainless Steel Finger	Steel Case**
MODEL 64* 	<ul style="list-style-type: none"> Severe service seal in steel mills, heavy equipment industry Assembled design 	8 thru 90 (203.2 thru 2286)	7000 (35.6)	0.125 @ 5000 (3.18 @ 25.4) 0.093 @ 7000 (2.36 @ 35.6)	Combination Carbon Steel* Garter and Stainless Steel Finger	Steel Outer Case** with Steel Inner Case†

FPM = feet per minute MPS = meters per second

Standard sealing element is nitrile.

MILL-RIGHT®, silicone and fluoroelastomer available.

*Stainless steel available on special order.

**Plated cases available on special order. Special tooling may be required for stainless steel cases.

Aluminum and brass cases thru 19.999 inches (507.97 mm)

O.D. on special order.

†Plated steel available on special order.







WARNING:

Properties/applications shown throughout this brochure are typical. Your specific application should not be undertaken without independent study and evaluation for suitability. For specific application recommendations consult Garlock. Failure to select the proper sealing products could result in property damage and/or serious personal injury.



Performance data published in this brochure has been developed from field testing, customer field reports and/or in house testing.

While the utmost care has been used in compiling this brochure, we assume no responsibility for errors. Specifications subject to change without notice. This edition cancels all previous issues. Subject to change without notice.

Single Lip - Spring Loaded General Purpose Lubricant Retention Seals

	Features	Shaft Diameters In. (MM)	Surface Speed FPM (MPS)	Misalignment & Runout In. @ FPM (MM @ MPS)	Spring	O.D. Construction
MODEL 66 	<ul style="list-style-type: none"> Equivalent to Model 76 with heavy duty case Assembled design 	3/8 thru 7-7/8 (9.5 thru 200)	3000 (15.2)	0.015 @ 1000 (0.38 @ 5.1) 0.010 @ 2000 (0.25 @ 10.2) 0.005 @ 3000 (0.13 @ 15.2)	Carbon Steel* Garter	Steel Case**
MODEL 67 	<ul style="list-style-type: none"> General purpose Strong sealing element Assembled design 	1/2 thru 3-1/4 (12.7 thru 82.5)	1000 (5.1)	0.010 @ 500 (0.25 @ 2.5) 0.005 @ 1000 (0.13 @ 5.1)	Carbon Steel* Garter	Steel Case**
MODEL 76 	<ul style="list-style-type: none"> General purpose Fits minimum space Bonded design 	1/4 thru 8 (6.4 thru 203.2) limited sizes available	3000 (15.2)	0.015 @ 1000 (0.38 @ 5.1) 0.010 @ 2000 (0.25 @ 10.2) 0.005 @ 3000 (0.13 @ 15.2)	Carbon Steel* Garter	Steel Case
MODEL 87 	<ul style="list-style-type: none"> Moderately severe service seal with rubber O.D. to ease installation Molded design Reverse bevel lip eliminates roll-over 	6 thru 48 (152.4 thru 1219.2)	5000 (25.4)	0.100 @ 2500 (2.54 @ 12.7) 0.050 @ 5000 (1.27 @ 25.4)	Carbon Steel Garter Encapsulated	Rubber Covered Steel Ring
MODEL 88 	<ul style="list-style-type: none"> Moderately severe service seal with rubber O.D. to ease installation Molded design Reverse bevel lip eliminates roll-over 	6 thru 48 (152.4 thru 1219.2)	5000 (25.4)	0.050 @ 2500 (1.27 @ 12.7) 0.025 @ 5000 (0.64 @ 25.4)	Carbon Steel Garter Encapsulated	Rubber Covered Steel Ring
MODEL 92 	<ul style="list-style-type: none"> Equivalent to Model 76 with rubber O.D. for non-ferrous housings Bonded design 	1/4 thru 12-1/2 (6.4 thru 317.5) limited sizes available	3000 (15.2)	0.015 @ 1000 (0.38 @ 5.1) 0.010 @ 2000 (0.25 @ 10.2) 0.005 @ 3000 (0.13 @ 15.2)	Carbon Steel* Garter	Rubber Covered Steel Case

Single Lip - No Spring - Retains Heavy Lubricants, Excludes Contaminants with Reverse Installation

	Features	Shaft Diameters In. (MM)	Surface Speed FPM (MPS)	Misalignment & Runout In. @ FPM (MM @ MPS)	Spring	O.D. Construction
MODEL 58 	<ul style="list-style-type: none"> THERMO-CERAM™ sealing element withstands high temperatures, abrasive applications For reciprocating and rotating equipment Ideal for steel industry 	2 thru 12 (50.8 thru 305)	500 (2.5)	0.015 @ 500 (0.38 @ 2.5)	None	Steel Case
MODEL 71 	<ul style="list-style-type: none"> General purpose standard seal Bonded design 	1/4 thru 7-1/4 (6.4 thru 184.2) limited sizes available	1000 (5.1)	0.005 @ 1000 (0.13 @ 5.1)	None	Steel Case
MODEL 91 	<ul style="list-style-type: none"> Equivalent to Model 71 with rubber O.D. for non-ferrous housings Bonded design 	9/32 thru 5 (7.1 thru 127) limited sizes available	1000 (5.1)	0.005 @ 1000 (0.13 @ 5.1)	None	Rubber Covered Steel Case

FPM = feet per minute MPS = meters per second

Standard sealing element is nitrile.

Model 57 available in nitrile, silicone MILL-RIGHT® and fluoroelastomer.

*Stainless steel available on special order.

**Plated cases available on special order. Special tooling may be required for stainless steel cases.



WARNING:

Properties/applications shown throughout this brochure are typical. Your specific application should not be undertaken without independent study and evaluation for suitability. For specific application recommendations consult Garlock. Failure to select the proper sealing products could result in property damage and/or serious personal injury.

Performance data published in this brochure has been developed from field testing, customer field reports and/or in house testing.

While the utmost care has been used in compiling this brochure, we assume no responsibility for errors. Specifications subject to change without notice. This edition cancels all previous issues. Subject to change without notice.

Dual Opposed Lips - Both Lips with Spring, Separates Lubricant from a Dissimilar Fluid

	Features	Shaft Diameters In. (MM)	Surface Speed FPM (MPS)	Misalignment & Runout In. @ FPM (MM @ MPS)	Spring	O.D. Construction
MODEL 53R2 	<ul style="list-style-type: none"> • Heavy duty case • Assembled design 	3 thru 15 (76.4 thru 381)	1000 (5.1)	0.010 @ 500 (0.25 @ 2.5) 0.005 @ 1000 (0.13 @ 5.1)	Stainless Steel Finger	Steel Case**
MODEL 63R2 	<ul style="list-style-type: none"> • Equivalent to Model 53R2 • Assembled design 	1/4 thru 3 (6.4 thru 76.2)	1000 (5.1)	0.010 @ 500 (0.25 @ 2.5) 0.005 @ 1000 (0.13 @ 5.1)	Stainless Steel Finger	Steel Case**







Standard sealing element is nitrile.

**Plated cases available on special order. Special tooling may be required for stainless steel cases.





FPM = feet per minute

MPS = meters per second

Dual Opposed Lips - One Lip with Spring, Sprung Lip Retains Lubricants, Un-Sprung Lip Excludes Contaminants

	Features	Shaft Diameters In. (MM)	Surface Speed FPM (MPS)	Misalignment & Runout In. @ FPM (MM @ MPS)	Spring	O.D. Construction
MODEL 3 	<ul style="list-style-type: none"> General purpose standard design Bonded design 	1/2 thru 7-1/4 (12.7 thru 184.2)	4000 (20.3)	0.015 @ 1000 (0.38 @ 5.1) 0.010 @ 2000 (0.25 @ 10.2) 0.005 @ 4000 (0.13 @ 20.3)	Carbon Steel* Garter	Steel Case
MODEL 26R1 	<ul style="list-style-type: none"> General purpose, non-metallic seal Molded one-piece construction 	3/4 thru 60 (19.4 thru 1524)	5000 (25.4)	0.015 @ 1000 (0.38 @ 5.1) 0.010 @ 2000 (0.25 @ 10.2) 0.008 @ 5000 (0.20 @ 25.4)	Stainless Steel Finger	Rubber with reinforced heel
MODEL 53R1 	<ul style="list-style-type: none"> Heavy duty case Assembled design Equivalent to Model 63R1 Assembled design 	53R1: 3 thru 15 (76.2 thru 381) 63R1: 1/4 thru 3 (6.4 thru 76.2)	2000 (10.2)	0.015 @ 1000 (0.38 @ 5.1) 0.10 @ 2000 (0.25 @ 10.2)	Stainless Steel Finger	Steel Case**
MODEL 53F1 	<ul style="list-style-type: none"> Felt element excludes contaminants Equivalent to Model 63F1 Assembled design 	53F1: 3 thru 15 (76.2 thru 381) 63F1: 1/4 thru 3 (6.4 thru 76.2)	1000 (5.1)	0.010 @ 1000 (0.25 @ 5.1)	Stainless Steel Finger	Steel Case**
MODEL 57 	<ul style="list-style-type: none"> Slow speed applications Caster applications Available with single and dual lips 	2 thru 12 (50.8 thru 304.8)	500 (2.5)	0.015 @ 500 (0.38 @ 2.5)	Stainless Steel Finger	Rubber Covered Steel Case
MODEL 94 	<ul style="list-style-type: none"> Equivalent to Model 3 with rubber O.D. for non-ferrous housings Bonded design 	7/16 thru 7-3/8 (11.1 thru 187.3)	3000 (15.2)	0.015 @ 1000 (0.38 @ 5.1) 0.10 @ 2000 (0.25 @ 10.2) 0.005 @ 3000 (0.13 @ 15.2)	Carbon Steel* Garter	Rubber Covered Steel Case

Dual Tandem Lips Retains Lubricants

	Features	Shaft Diameters In. (MM)	Surface Speed FPM (MPS)	Misalignment & Runout In. @ FPM (MM @ MPS)	Spring	O.D. Construction
MODEL 53TB 	<ul style="list-style-type: none"> Non-sprung front lip serves as a baffle Sprung back lip for effective sealing Assembled design 	3 thru 15 (76.2 thru 381)	1000 (5.1)	0.010 @ 500 (0.25 @ 2.5) 0.005 @ 1000 (0.13 @ 5.1)	Stainless Steel Finger	Steel Case**
MODEL 63TB 	<ul style="list-style-type: none"> Non-sprung front lip serves as a baffle Sprung back lip for effective sealing Assembled design 	1/4 thru 3 (6.4 thru 76.2)	1000 (5.1)	0.010 @ 500 (0.25 @ 2.5) 0.005 @ 1000 (0.13 @ 5.1)	Stainless Steel Finger	Steel Case**
MODEL 53T2 	<ul style="list-style-type: none"> Both lips have spring for effective sealing Assembled design 	3 thru 15 (76.2 thru 381)	1000 (5.1)	0.010 @ 500 (0.25 @ 2.5) 0.005 @ 1000 (0.13 @ 5.1)	Stainless Steel Finger	Steel Case*
MODEL 63T2 	<ul style="list-style-type: none"> Both lips have spring for effective sealing Assembled design 	1/4 thru 3 (6.4 thru 76.2)	1000 (5.1)	0.010 @ 500 (0.25 @ 2.5) 0.005 @ 1000 (0.13 @ 5.1)	Stainless Steel Finger	Steel Case*

FPM = feet per minute MPS = meters per second

Standard sealing element is nitrile.

*Stainless steel available on special order.

**Plated cases available on special order. Special tooling may be required for stainless steel cases.

WARNING:

Properties/applications shown throughout this brochure are typical. Your specific application should not be undertaken without independent study and evaluation for suitability. For specific application recommendations consult Garlock. Failure to select the proper sealing products could result in property damage and/or serious personal injury.

Performance data published in this brochure has been developed from field testing, customer field reports and/or in house testing.

While the utmost care has been used in compiling this brochure, we assume no responsibility for errors. Specifications subject to change without notice. This edition cancels all previous issues. Subject to change without notice.





ООО «ТИ-СИСТЕМС» ИНЖИНИРИНГ И ПОСТАВКА ТЕХНОЛОГИЧЕСКОГО ОБОРУДОВАНИЯ

Интернет: www.tisys.ru www.tisys.kz www.tisys.by www.tesec.ru www.ти-системс.рф

Телефоны: +7 (495) 7774788, 7489626, (925) 5007155, 54, 65 Эл. почта: info@tisys.ru info@tisys.kz info@tisys.by

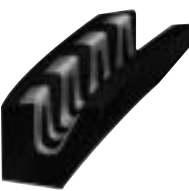
Single Lip Split - Retains Lubricants[†]

Eliminates Costly Equipment Teardown

	Features	Shaft Diameters In. (MM)	Surface Speed FPM (MPS)	Misalignment & Runout In. @ FPM (MM @ MPS)	Spring	O.D. Construction
MODEL 21 	<ul style="list-style-type: none"> Low speed service seal Cover plate required for sealing installation 	3 thru 42 (76.2 thru 1066.8)	1000 (5.1)	0.010 @ 500 (0.25 @ 2.5) 0.005 @ 1000 (0.13 @ 5.1)	Molded in Stainless Steel Finger	Molded Rubber
MODEL 23 	<ul style="list-style-type: none"> General purpose service seal Cover plate required for sealing installation 	3 and up (76.2 and up)	2000 (10.2)	0.010 @ 1000 (0.25 @ 5.1) 0.005 @ 2000 (0.13 @ 10.2)	Molded in Stainless Steel Finger	Molded Rubber
MODEL 24 	<ul style="list-style-type: none"> Low speed service seal Tapered O.D. fits in tapered groove in housing Improved replacement for felt rings 	3 thru 21-1/2 (76.2 thru 546.1)	1000 (5.1)	0.010 @ 500 (0.25 @ 2.5) 0.005 @ 1000 (0.13 @ 5.1)	Molded in Stainless Steel Finger	Molded Rubber
MODEL 25 	<ul style="list-style-type: none"> PTFE element for extremely severe chemicals Cover plate required for sealing 	3 thru 20 max. O.D. (76.2 thru 508)	1000 (5.1)	0.010 @ 500 (0.25 @ 2.5) 0.005 @ 1000 (0.13 @ 5.1)	Carbon Steel** Garter	PTFE
MODEL 26 	<ul style="list-style-type: none"> General purpose non-metallic seal Molded one piece construction No cover plate required Reinforced heel 	1/4 thru 60 (19.4 thru 1524)	5000 (25.4)	0.015 @ 1000 (0.37 @ 5.1) 0.010 @ 2000 (0.25 @ 10.2) 0.008 @ 5000 (0.20 @ 25.4)	Stainless Steel Finger	Rubber with reinforced heel

Standard sealing element for Models 21, 23 and 24 is nitrile.
MILL-RIGHT®, silicone and fluoroelastomer available.

Bonded spring in Models 21, 23 and 24 allows for simplified installation.



*Stainless steel available on special order.

[†]Preferred applications on grease lubricated or liquid level below shaft centerline.

FPM = feet per minute

MPS = meters per second

External Lip Seals

	Features	Shaft Diameters In. (MM)	Surface Speed FPM (MPS)	Misalignment & Runout In. @ FPM (MM @ MPS)	Spring	O.D. Construction
MODEL 111 	<ul style="list-style-type: none"> External lip seal Low speed service Assembled design 	3 thru 50 (76.2 thru 1270) limited sizes available	1000 (5.1)	0.010 @ 500 (0.25 @ 2.5) 0.005 @ 1000 (0.13 @ 5.1)	Stainless Steel Finger	Steel Case*
MODEL 113 	<ul style="list-style-type: none"> External lip seal Moderate speed service Assembled design 	3 thru 50 (76.2 thru 1270) limited sizes available	3000 (15.2)	0.020 @ 1000 (0.50 @ 5.1) 0.10 @ 2000 (0.25 @ 10.2) 0.005 @ 3000 (0.13 @ 15.2)	Stainless Steel Finger	Steel Case*
MODEL 123 	<ul style="list-style-type: none"> External lip seal Moderate speed service Assembled design 	1-5/32 thru 50 (29.4 thru 1270) limited sizes available	3000 (15.2)	0.020 @ 1000 (0.50 @ 5.1) 0.10 @ 2000 (0.25 @ 10.2) 0.005 @ 3000 (0.13 @ 15.2)	Stainless Steel Finger	Steel Case*

FPM = feet per minute MPS = meters per second

Standard sealing element for Models 21, 23 and 24 is nitrile. MILL-RIGHT®, silicone and fluoroelastomer available. Bonded spring in Models 21, 23 and 24 allows for simplified installation.

*Stainless steel available on special order.

*Preferred applications on grease lubricated or liquid level below shaft centerline.

WARNING:

Properties/applications shown throughout this brochure are typical. Your specific application should not be undertaken without independent study and evaluation for suitability. For specific application recommendations consult Garlock. Failure to select the proper sealing products could result in property damage and/or serious personal injury.

Performance data published in this brochure has been developed from field testing, customer field reports and/or in house testing.

While the utmost care has been used in compiling this brochure, we assume no responsibility for errors. Specifications subject to change without notice. This edition cancels all previous issues. Subject to change without notice.

Special Purpose

MODEL 54 Seal for Spherical Bearings

- L - Distance from bearing center to back of KLOZURE®
- R - Radius of spherical surface*
- B - Housing bore*
- C - KLOZURE® width*

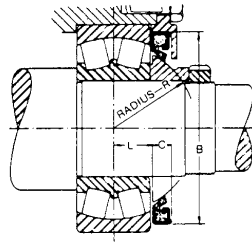

*In the final layout these Model 54 tangential KLOZURE® dimensions as supplied may have to be altered, but dimensions will be used as a guide in designing the KLOZURE®. In addition to the foregoing dimensions, a data sheet giving pertinent operating information should be supplied.

Available sizes, Model 54 tangential KLOZURES®
Information on other sizes on request

	"R" radius		"B" bore		"C" width		"L"		KLOZURE® Part No.
	in.	mm	in.	mm	+1/64"	0.4 mm	in.	mm	
2-3/8	60.33	5.125	130.18	5/8	15.88	1-7/32	30.96	54x6003	
2-3/4	69.85	6.000	152.40	5/8	15.88	1-17/64	32.15	54x6005	
3-3/8	85.73	6.500	165.10	5/8	15.88	2-1/16	52.39	54x9733	
3-9/16	90.49	7.250	184.15	9/16	14.29	1-45/64	43.26	54x6008	
4	101.6	8.000	203.20	5/8	15.88	2-1/4	57.15	54x6010	
4-1/4	107.95	8.250	209.55	5/8	15.88	2-1/2	63.50	54x7351	
4-3/8	111.13	9.125	231.78	5/8	15.88	2	50.80	54x6014	
4-3/4	120.65	9.250	234.95	5/8	15.88	2-5/8	66.68	54x9986	
5	127.00	9.750	247.65	5/8	15.88	2-3/4	69.85	54x6018	
5-1/4	133.35	10.750	273.05	11/16	17.46	2-1/2	63.50	54x6020	
5-5/8	142.88	11.375	288.93	1	25.40	2-11/16	68.26	54x6021	
6-5/8	168.28	12.500	317.50	5/8	15.88	3-3/8	85.73	54x6023	
7	177.80	13.500	342.90	3/4	19.05	3-5/16	84.14	54x6024	
8	203.20	14.750	374.65	5/8	15.88	4-1/8	104.78	54x9750	

MODEL 142 Steel Mill Water Seal

Radial height x 2 + shaft dia. = O.D. (excluding clamp)
Axial width is overall width.

All elements are nitrile only. All steel parts including clamps are carbon steel. Spring is stainless steel. These are the only materials available for this model.

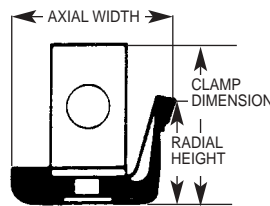

	Cross Section Radial Height		Cross Section Axial Width		Shaft Diameter or Minimum I.D. to which assembly can be formed		Clamp dimension	
	in.	mm	in.	mm	in.	mm	in.	mm
1/2	12.7	3/4	19.05	7-1/2	190.50	1-1/4	31.75	
9/16	14.29	1-1/4	31.75	12	304.80	1-5/16	33.34	
9/16	14.29	1-5/16	33.34	12	304.80	1-5/16	33.34	
9/16	14.29	1-3/8	34.93	12	304.80	1-5/16	33.34	
3/4	19.05	1	25.40	18	457.20	1-1/8	28.58	
1	25.40	1-1/4	31.75	30	762.00	1-11/32	34.13	
1	25.40	1-3/8	34.93	30	762.00	1-11/32	34.13	
1	25.40	1-1/2	38.10	30	762.00	1-11/32	34.13	

MODEL 145A-1 Face Type Excluder Seal

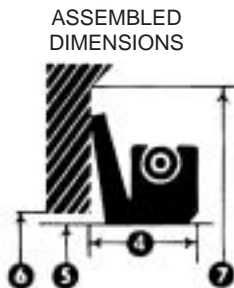

1. Height of cross section = 1" (25.4 mm)
2. Shaft contact width = 1-11/32" (34.1 mm)
3. Overall free width = 2-19/32" (65.9 mm)
4. Assembled width = 2 ± 1/2" (50.8 ± 12.7 mm)
5. Shaft diameter
6. Maximum face bore = shaft + 1" (shaft + 25.4 mm)
7. Minimum face dia. = shaft + 4-1/2" (shaft + 114.3 mm)

MODEL 145A-2 Face Type Excluder Seal

CROSS SECTION DIMENSIONS

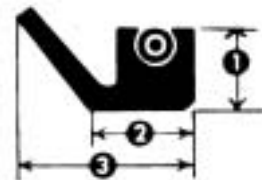

1. Height of cross section = 1/2" (12.7 mm)
2. Shaft contact width = 9/16" (14.3 mm)
3. Overall free width = 31/32" (24.6 mm)
4. Assembled width = 25/32" ± 5/32" (19.8 mm ± 4.0 mm)
5. Shaft diameter
6. Maximum face bore = shaft + 25/64" (shaft + 9.9 mm)
7. Minimum face dia. = shaft + 1-3/4" (shaft + 44.5 mm)

Special Purpose

MICRO-TEC® Bearing Protector Seal



Utilizing Microcellular Technology

Unique, engineered microcellular materials interact with the sealing media to create a barrier to lubricant leakage and contamination ingestion. An application data sheet must be completed to order these seals. Contact your local Garlock representative or authorized Garlock distributor for details.

Operating Specifications

Parameters	Standard	Optional
Speed	0 - 3,600 RPM	10,000 = RPM
Misalignment and Runout	0.060" TIR [†] (1.52mm TIR)	>0.060" TIR (1.52 mm) TIR
Axial Misalignment	0.010" (0.254 mm)	>0.010" (0.254 mm)
Pressure	Ambient	7.5 psi (0.5 bar)
Temperature	-40°F to 400°F (-40°C to 205°C)	>400°F (205°C)

[†]TIR = Total Indicator Reading

Available Materials

Component	Standard	Optional
Rotor and Stator	Aluminum, black anodized coating	Stainless Steel Carbon Steel PTFE
O-Rings	Fluoroelastomer for chemical and temperature resistance	silicone PTFE Buna-N Nitrile
Micro-cellular Materials	Low Density , seals out viscous materials, Medium Density , seals out less viscous materials High Density , seals out airborne contaminants	Specialized cellular materials available for extreme applications

WARNING:

Properties/applications shown throughout this brochure are typical. Your specific application should not be undertaken without independent study and evaluation for suitability. For specific application recommendations consult Garlock. Failure to select the proper sealing products could result in property damage and/or serious personal injury. Performance data published in this brochure has been developed from field testing, customer field reports and/or in house testing. While the utmost care has been used in compiling this brochure, we assume no responsibility for errors. Specifications subject to change without notice. This edition cancels all previous issues. Subject to change without notice.

EQUALIZER® The Ultimate Bearing Protector

Features	Benefits
Graphite-filled PTFE construction standard	Handles high temperatures Resists most chemicals Alternate materials available
One-piece assembled design	Cannot come apart during installation or operation
Highest misalignment and runout allowed	Standard design accepts 0.015" (0.38 mm) total misalignment and runout
Sixteen expulsion ports	Seal installs in any rotational position eliminating installation errors
Narrow cross-section design available	3/16" (4.76 mm) minimum cross-section eliminates the need to re bore housings

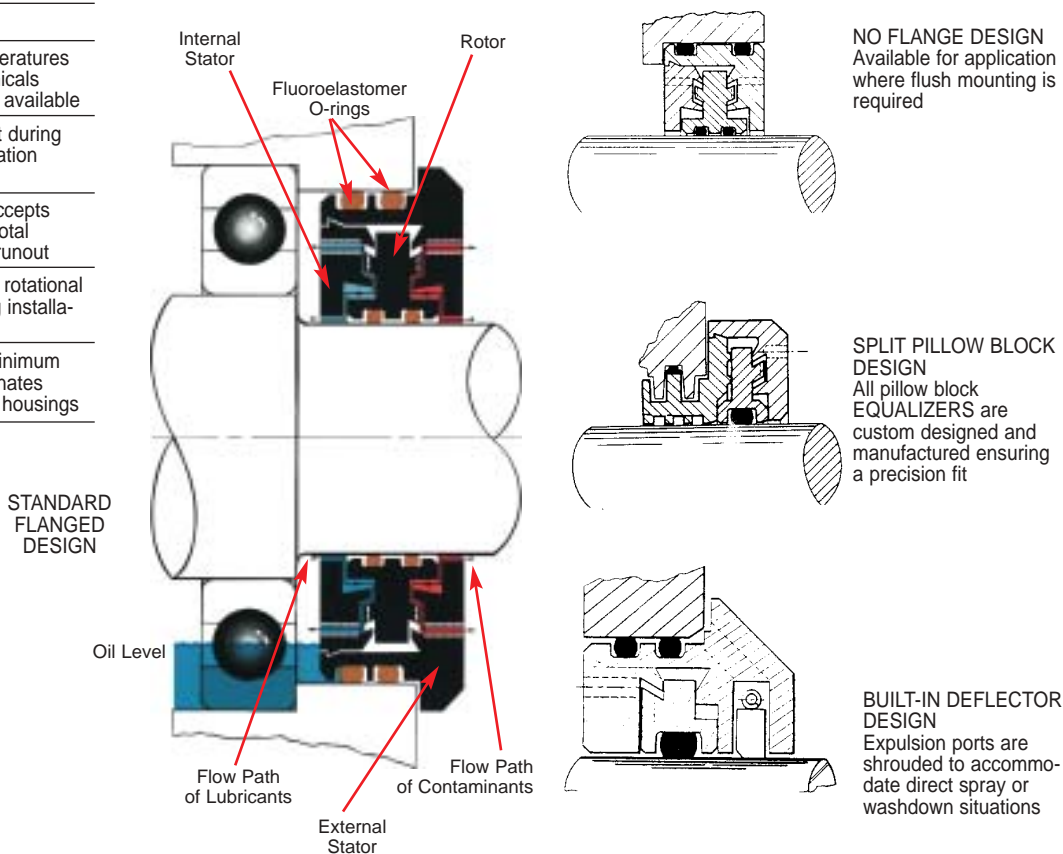

Bearing Isolators

ISO-GARD® Bearing Isolators



Standard ISO-GARD®

- The most aggressive labyrinth in the industry, for superior contaminant exclusion
- Two-piece unitized construction won't come apart during installation
- Supports predictive maintenance programs and reduces unscheduled downtime
- PTFE material provides excellent chemical resistance and wide temperature capability
- Non-contact design eliminates shaft scoring, drag and frictional heat—no lubrication required
- Press-fit design means easy installation—no tools required
- Performs in accordance with NEMA MGI as required by IEEE Std. 841
- Constructed of FDA-compliant, glass-filled PTFE material†

† Available with FDA-compliant O-rings.

Specifications

Material:	Blue, glass-filled PTFE
Temperature:	-40°F to +400°F (-40°C to +204°C)
Surface speed:	To 4,500 fpm (22.9 m/s)
Axial motion:	±0.015" (0.38 mm)
Misalignment and runout:	±0.020" (0.50 mm)
Pressure:	Ambient*

* 5 psi for Grease-Purgeable ISO-GARD®

- Also available in grease purgeable, flangeless and vertical designs
- Also available in graphite-filled PTFE, stainless steel filled PTFE, bronze and stainless steel material

WARNING:

Properties/applications shown throughout this brochure are typical. Your specific application should not be undertaken without independent study and evaluation for suitability. For specific application recommendations consult Garlock. Failure to select the proper sealing products could result in property damage and/or serious personal injury.

Performance data published in this brochure has been developed from field testing, customer field reports and/or in house testing.

While the utmost care has been used in compiling this brochure, we assume no responsibility for errors. Specifications subject to change without notice. This edition cancels all previous issues. Subject to change without notice.

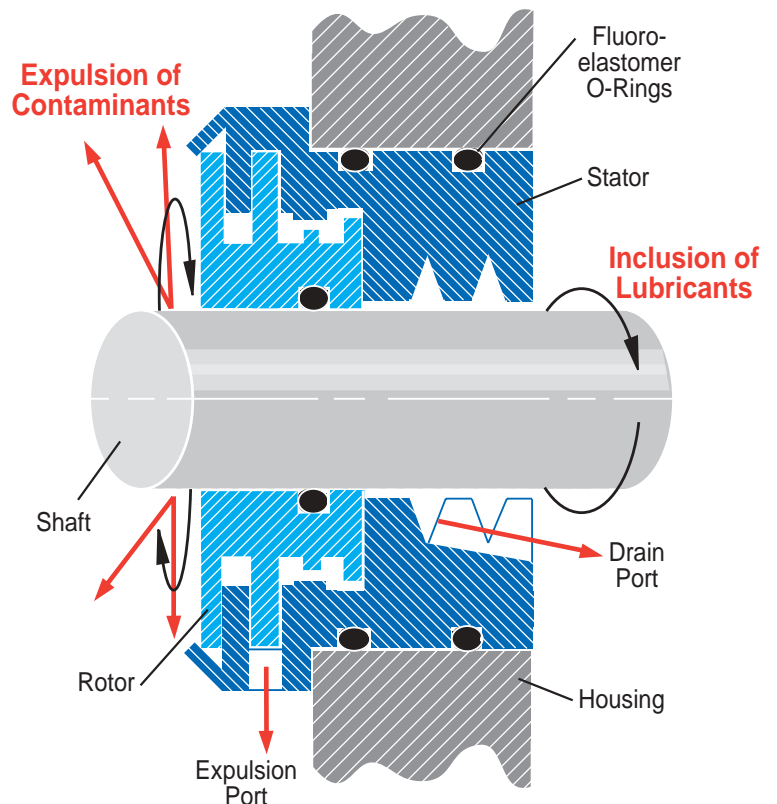

General Engineering Data

Garlock precision-made KLOZURE® Oil Seals are designed and engineered to give long and effective service on any job for which an oil seal is required.

Satisfactory sealing service cannot be achieved unless the shaft and surrounding machine parts are in proper mechanical condition. Shaft speeds, temperatures and other operating factors also have an important bearing upon all seal performance. Recommended practices and limitations affecting oil seal applications are set forth in the following paragraphs and tables.

Shaft finish

The degree of sealing efficiency of an oil seal is almost in direct proportion to the condition of the shaft surface in contact with the sealing member. Rough, poorly finished shafts, or shafts with turning or grinding spirals or "threads", cannot be effectively sealed. New sealing surfaces are required for the replacement oil seal. See Table 1 for specific recommendations.

Shaft-to-bore misalignment and dynamic runout

Shaft-to-bore misalignment is defined as the distance by which the shaft is off-center with respect to the bore.

Dynamic runout is defined as the amount by which the shaft (at the sealing surface) does not rotate around the true center. It is measured by the total movement of a dial indicator held against the shaft surface while the shaft is slowly rotated (see Figure A, Page 16). This is read as total indicator reading, or TIR.

Perfect concentricity of the shaft and housing is rarely possible or necessary, but the faster the shaft turns, the more nearly concentric the two should be. Excessive misalignment causes uneven wear and can shorten seal life. Good practice dictates that the shaft-to-bore misalignment not exceed 0.010" (0.25 mm).

Similarly, dynamic runout affects sealing efficiency and should be kept below 0.010" (0.25 mm) TIR.

Pressure data

Standard oil seals should not be used when the operating pressure exceeds the limits shown in Table 2, Page 15.

When variable surge pressures exceeding the above limits are present, a special condition exists and full details should be submitted for engineering recommendation.

Higher operating pressures may be feasible if a custom seal is considered. However, when a pressure seal is used, features such as the ability to take greater eccentricities are sacrificed. Whenever possible, the equipment design should be such that the system is vented. This will allow the seal to function more efficiently.

Tolerance

Close tolerances in the finished dimensions of the shaft, in the bore of the housing, and in the oil seal itself are essential to

satisfactory seal performance. See Tables 3, 4 and 5, Page 15 and 16.

The bore tolerances apply only to ferrous materials. When non-ferrous materials such as aluminum are used, full details should be submitted for recommendation. Seal width tolerance is $\pm 1/64"$ (0.4 mm).

Standard seal torque

Torque readings for oil seals can be as varied as the number of different oil seal applications. Factors that vitally affect the dependability and uniformity of a torque reading include (1) rate and uniformity of shaft rotation, (2) amount of lubrication, (3) type of lubrication, (4) ambient temperatures, (5) shaft finish, (6) seal alignment, and (7) sealing element material. Due to these factors, oil seal torque figures, to be of value, must be developed for each application.

Important note

The recommendations in this catalog as to shaft finishes, misalignment, runout, speeds, temperatures and tolerances are those generally applicable, but they are not to be interpreted as applying, without reservation or exception, to each and every application. The model and type of seal selected for a given application, and other conditions surrounding that application, may modify these average limitations one way or the other. Therefore, it is desirable in most cases to provide full information to Garlock and let our experienced staff of engineers submit a recommendation.

Table 1
Shaft Data

Hardness	Rockwell C 30 to 40 (Rockwell C 45 minimum will provide extra protection against damage during handling or assembly)
Finish (Plunge grind is recommended as most satisfactory)	10-20 μ in. AA (0.25-0.50 micrometers) with no machine lead, scratches, dents, corrosion, pits or other surface defects
Surface speed*	Formula: Feet-Per-Min. = Shaft Dia. (in) x RPM x 0.262 Meters-Per-Sec. = Shaft Dia. (mm) x RPM x 0.0000524
Safe speed depends on**	1. Shaft finish 2. Misalignment and runout 3. Amount and kind of lubricant 4. Seal design 5. Pressure

* Pages 1 thru 10 show recommended KLOZURE® Oil Seals for various speeds and operating conditions.

** As shaft speed increases, the factors become more critical.

General Engineering Data Tables

Table 2
Operating Pressure Limits

Shaft Speed		Maximum* Pressure	
Feet per Minute	Meters per Second	Pounds per Square Inch	Kilo-Pascals
0 - 1000	0 - 5.1	7	48
1001 - 2000	5.2 - 10.2	5	35
2001 & Up	10.3 & Up	3	21

*Split KLOZURE® Oil Seals are not recommended for applications involving fluid pressure

Table 3
Shaft Diameter Tolerances

Shaft Diameter		Recommended Tolerance	
Inch	Millimeter	Inch	Millimeter
Up thru 4.000	Up thru 101.60	±0.003	±0.08
4.001 - 6.000	101.61 - 152.40	±0.004	±0.10
6.001 - 10.000	152.41 - 254.00	±0.005	±0.13
10.001 & Up	254.01 & Up	±0.006	±0.15

Table 4
Bore Tolerance and Seal Press Fits for Metal O.D. Seals

Housing Bore Diameter (Nominal)		Recommended Bore Diameter Tolerance†		Press Fit* Range	
Inch	Millimeter	Inch	Millimeter	Inch	Millimeter
Thru 1.000	Thru 25.40	±0.001	±0.03	0.002 to 0.006	0.05 to 0.15
1.001 - 3.000	25.41 - 76.20	±0.001	±0.03	0.002 to 0.007	0.05 to 0.18
3.001 - 4.000	76.21 - 101.60	±0.0015	±0.04	0.003 to 0.007	0.08 to 0.18
4.001 - 4.375	101.61 - 111.13	±0.0015	±0.04	0.003 to 0.008	0.08 to 0.20
4.376 - 6.000	111.14 - 152.40	±0.0015	±0.04	0.003 to 0.010	0.08 to 0.25
6.001 - 7.000	152.41 - 177.80	±0.002	±0.05	0.004 to 0.011	0.10 to 0.28
7.001 - 8.000	177.81 - 203.20	±0.002	±0.05	0.004 to 0.013	0.10 to 0.33
8.001 - 9.000	203.21 - 228.60	±0.002	±0.05	0.005 to 0.014	0.13 to 0.36
9.001 - 10.000	228.61 - 254.00	±0.002	±0.05	0.006 to 0.016	0.15 to 0.41
10.001 - 20.000	254.01 - 508.00	+0.002 -0.004	+0.05 -0.10	0.006 to 0.020	0.15 to 0.51
20.001 - 30.000	508.01 - 762.00	+0.002 -0.006	+0.05 -0.15	0.006 to 0.024	0.15 to 0.61
30.001 - 40.000	762.01 - 1016.00	+0.002 -0.006	+0.05 -0.15	0.006 to 0.026	0.15 to 0.66
40.001 - 60.000	1016.01 - 1524.00	+0.002 -0.010	+0.05 -0.25	0.006 to 0.03	0.15 to 0.81

† Recommended Bore Finish = 100 microinches AA (2.54 micrometers) or smoother.

* Press Fit = Seal O.D. minus nominal bore diameter (Seal O.D. is the average of a minimum of three measurements taken at equally spaced positions).

WARNING:

Properties/applications shown throughout this brochure are typical. Your specific application should not be undertaken without independent study and evaluation for suitability. For specific application recommendations consult Garlock. Failure to select the proper sealing products could result in property damage and/or serious personal injury.

Performance data published in this brochure has been developed from field testing, customer field reports and/or in house testing.

While the utmost care has been used in compiling this brochure, we assume no responsibility for errors. Specifications subject to change without notice. This edition cancels all previous issues. Subject to change without notice.

General Engineering Data Tables

Table 5
Bonded Lip Type Seals

Bore Diameter		Press Fit Allowance				Tolerance			
		Metal Case		Rubber Covered Case		Metal Case		Rubber Covered Case	
Inch	mm	Inch	mm	Inch	mm	Inch	mm	Inch	mm
Up to 1.000	Up to 25.40	+0.004	+0.10	+0.006	+0.15	±0.002	±0.05	±0.003	±0.08
1.001 - 2.000	25.43 - 50.8	+0.004	+0.10	+0.007	+0.18	±0.002	±0.05	±0.003	±0.08
2.001 - 3.000	50.83 - 76.2	+0.004	+0.10	+0.010	+0.25	±0.002	±0.05	±0.003	±0.08
3.001 - 4.000	76.23 - 101.6	+0.005	+0.13	+0.010	+0.25	±0.002	±0.05	±0.004	±0.10
4.001 - 6.000	101.63 - 152.4	+0.005	+0.13	+0.012	+0.30	+0.003 -0.002	+0.08 -0.05	±0.004	±0.10
6.001 - 8.000	152.43 - 203.2	+0.006	+0.15	+0.012	+0.30	+0.003 -0.002	+0.08 -0.05	±0.004	±0.10
8.001 - 10.000	203.23 - 254.0	+0.008	+0.20	+0.012	+0.30	+0.004 -0.002	+0.10 -0.10	±0.004	±0.10
10.001 - 20.000	254.03 - 508.0	+0.008	+0.20	+0.015	+0.38	+0.006 -0.002	+0.15 -0.05	±0.005	±0.13

Rubber O.D. Seals
Model 57

Bore Diameter		Press Fit		Tolerance	
Inch	mm	Inch	mm	Inch	mm
3.000	76.2	0.009	0.23	±0.004	±0.10
3.001 - 5.000	76.23 - 127.0	0.010	0.25	±0.004	±0.10
5.001 - 6.000	127.03 - 152.4	0.012	0.30	±0.005	±0.13
6.001 - 10.000	152.43 - 254.0	0.012	0.30	±0.005	±0.13
10.001 - 20.000	254.03 - 508.0	0.015	0.38	±0.005	±0.13

Model 87/88

Bore Diameter		Press Fit		Tolerance	
Inch	mm	Inch	mm	Inch	mm
6.000 - 8.000	152.4 - 203.2	0.018	0.46	±0.006	±0.15
8.001 - 12.000	203.23 - 304.8	0.020	0.51	±0.008	±0.20
12.001 - 23.749	304.83 - 603.2	0.025	0.64	±0.008	±0.20
23.750 - 48.000	603.25 - 1219.2	0.030	0.76	±0.010	±0.25

Figure A
Shaft to Bore Misalignment

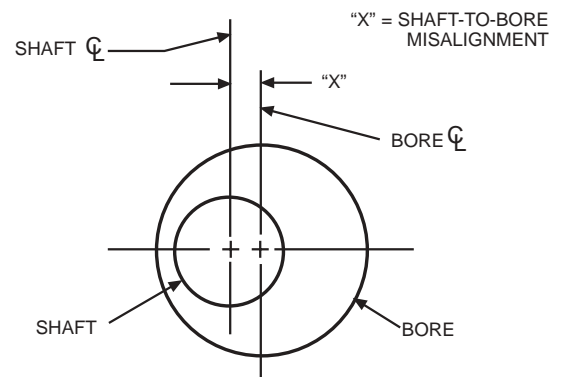
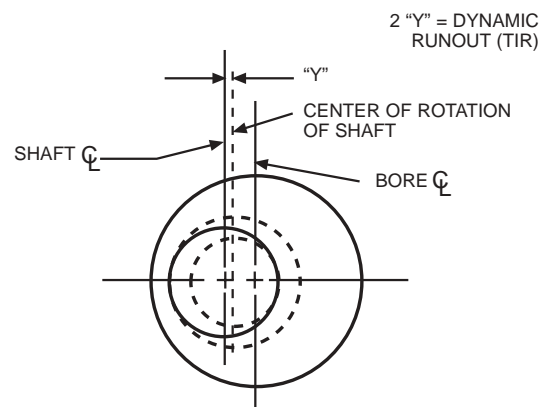

Figure B
Dynamic Runout



General Engineering Data Tables

Model 26

Bore Diameter		Press Fit Allowance		Tolerance	
Inch	mm	Inch	mm	Inch	mm
1.000 - 2.999	25.40 - 76.2	0.025	0.64	±0.005	±0.13
3.000 - 5.999	76.2 - 152.4	0.028	0.71	+0.010 -0.005	+0.25 -0.13
6.000 - 7.999	152.4 - 203.2	0.030	0.76	+0.010 -0.005	+0.25 -0.13
8.000 - 9.999	203.2 - 254.0	0.035	0.89	+0.010 -0.005	+0.25 -0.13
10.000 - 10.999	254.0 - 279.4	0.040	1.02	+0.010 -0.005	+0.25 -0.13
11.000 - 11.999	279.4 - 304.8	0.045	1.14	+0.010 -0.005	+0.25 -0.13
12.000 - 12.999	304.8 - 330.2	0.048	1.22	±0.010	±0.25
13.000 - 13.999	330.2 - 355.6	0.050	1.27	±0.010	±0.25
14.000 - 15.999	355.6 - 406.4	0.055	1.40	±0.010	±0.25
16.000 - 16.999	406.4 - 431.8	0.060	1.52	±0.010	±0.25
17.000 - 17.999	431.8 - 457.2	0.065	1.65	±0.010	±0.25
18.000 - 18.999	457.2 - 482.6	0.070	1.78	±0.010	±0.25
19.000 - 20.999	482.6 - 533.4	0.075	1.91	±0.010	±0.25
21.000 - 21.999	533.4 - 558.8	0.080	2.03	±0.015	±0.38
22.000 - 22.999	558.8 - 584.2	0.085	2.16	±0.015	±0.38
23.000 - 23.999	584.2 - 609.6	0.090	2.29	±0.015	±0.38
24.000 - 24.999	609.6 - 635.0	0.093	2.36	±0.015	±0.38
25.000 - 25.999	635.0 - 660.4	0.095	2.41	±0.015	±0.38
26.000 and Up	660.4 and Up	0.100	2.54	±0.015	±0.38

WARNING:

Properties/applications shown throughout this brochure are typical. Your specific application should not be undertaken without independent study and evaluation for suitability. For specific application recommendations consult Garlock. Failure to select the proper sealing products could result in property damage and/or serious personal injury.

Performance data published in this brochure has been developed from field testing, customer field reports and/or in house testing.

While the utmost care has been used in compiling this brochure, we assume no responsibility for errors. Specifications subject to change without notice. This edition cancels all previous issues. Subject to change without notice.

Nomenclature

Figure C
Assembled Design

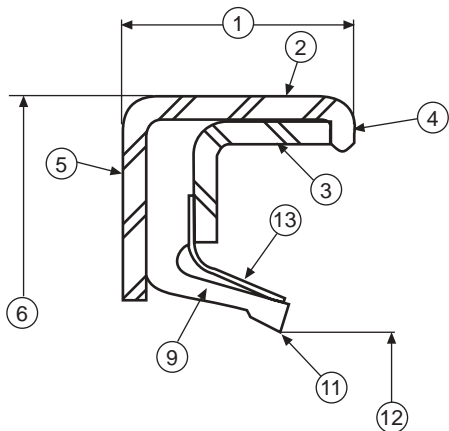
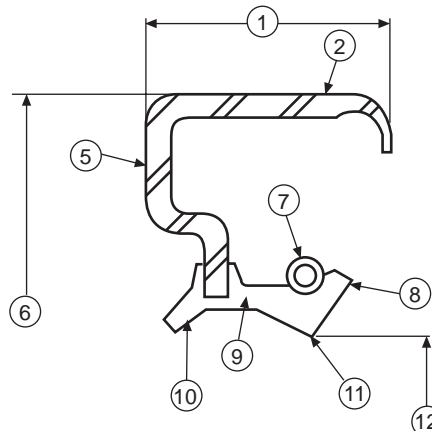

Figure D
Bonded Design



- | | |
|------------------------|--------------------------|
| 1. Case Width | 8. Spring Retaining Clip |
| 2. Outer Case | 9. Flex Section |
| 3. Inner Case | 10. Secondary Lip |
| 4. Inside Face | 11. Control Line |
| 5. Outside Face | 12. Lip Diameter |
| 6. Seal Outer Diameter | 13. Finger Spring |
| 7. Garter Spring | |

Figure E
Shaft & Housing

1. Shaft Diameter
2. Bore Diameter
3. Bore Depth
4. Shaft Lead Corner
5. Bore Lead in Chamfer
6. Corner Radius

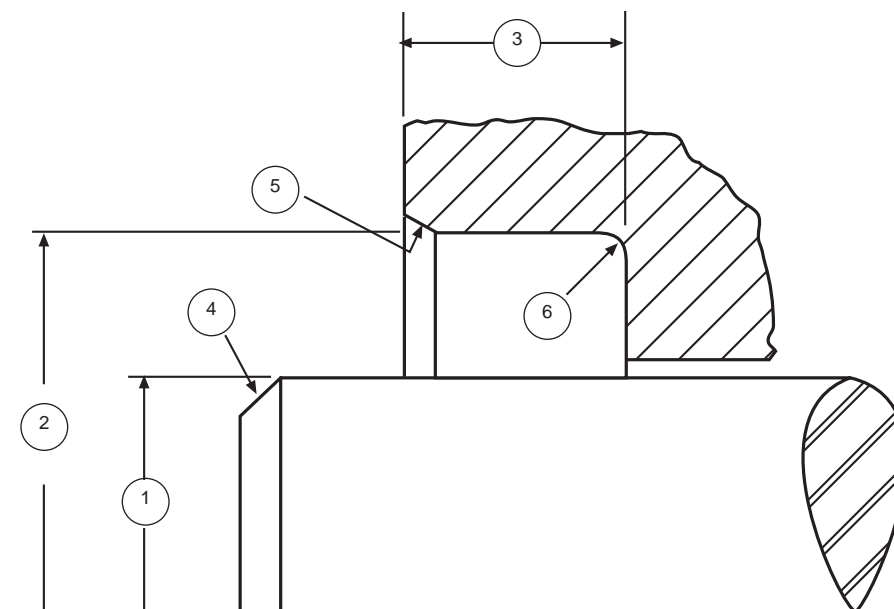

WARNING:

Properties/applications shown throughout this brochure are typical. Your specific application should not be undertaken without independent study and evaluation for suitability. For specific application recommendations consult Garlock. Failure to select the proper sealing products could result in property damage and/or serious personal injury.

Performance data published in this brochure has been developed from field testing, customer field reports and/or in house testing.

While the utmost care has been used in compiling this brochure, we assume no responsibility for errors. Specifications subject to change without notice. This edition cancels all previous issues. Subject to change without notice.

Selection Charts for Seal Elements

Advantages	Nitriles	MILL-RIGHT ^{®††}	Silicones	Fluoroelastomers Viton* Fluorel†	TFE fluoro-carbon Teflon**
	Low cost Good oil and abrasion resistance Good low temperature and swell characteristics	Good oil resistance Excellent abrasion resistance Good heat resistance Good low temperature and swell characteristics	Good heat resistance Excellent low temperature properties	Resistant to wide variety of additives and fluids Exceptional heat resistance Low swell characteristics	Offers practically universal resistance to fluid media Low friction material Good heat resistance
Disadvantages	Lacks exceptional heat resistance Tendency to harden during high temperature usage	Can be difficult to split due to the toughness of the material Chemical resistance similar to nitrile	High swell characteristics in some lubricants Poor chemical resistance to oxidized oils and some EP additives Poor dry running characteristics Easily damaged by handling	High cost Special tooling may be required	Poor seal performance with high runout or misalignment Special tooling usually required High cost Susceptible to installation damage

Mechanical, Temperature Compatibility

Durometer	70-90	75	80	70-80	—
Compression	Good	Good	Good	Good	—
Dry Running	Good	Good	Poor	Fair	Good
Abrasion Resistance	Good	Excellent	Poor	Fair	Good
Min Operating Temp	-40°F (-40°C)	-40°F (-40°C)	-75°F (-60°C)	-22°F (-30°C)	-120°F (-85°C)
Max Spike Temp	250°F (122°C)	350°F (175°C)	400°F (205°C)	450°F (232°C)	450°F (232°C)
Max Cont Operating	200°F (95°C)	300°F (150°C)	350°F (175°C)	400°F (205°C)	400°F (205°C)
Ozone Resistance	Fair	Good	Good	Good	Good
ATF	Good	Good	Good	Good	Good
Brake Fluid	Poor	Poor	Poor	Fair	Good
Butane	Good	Good	Fair	Good	Good
Engine Oil	Good	Good	Good	Good	Good
EP Lube	Fair	Fair	Poor	Good	Good
Freon	Good	Good	Poor	Fair	Good
Fuel Oil	Good	Good	Poor	Good	Good
Gasoline	Good	Good	Poor	Good	Good
Grease	Good	Good	Fair	Good	Good
Hydraulic Oil (pet. base)	Good	Good	Good	Good	Good
Ketones	Poor	Poor	Poor	Poor	Good
MIL-L-2105B	Fair	Fair	Poor	Fair	Good
MIL-L-5606B	Good	Good	Poor	Good	Good
MIL-L-6082C	Good	Good	Good	Good	Good
MIL-L-7808F	Fair	Fair	Good	Good	Good
MIL-L-10924B	Good	Good	Poor	Good	Good
Perchloroethylene	Fair	Fair	Poor	Good	Good
Phosphate Ester	Poor	Poor	Good	Good	Good
SAE 90	Good	Good	Poor	Good	Good
Skydrol 500***	Poor	Poor	Good	Poor	Good
Water (Fresh)	Good	Good	Good	Good	Good
Water (Salt)	Good	Good	Good	Good	Good

The above ratings are general with respect to different polymers. Specific ratings depend on the specific compound, specific fluid, temperature and degree of exposure of immersion.

* DuPont Dow Elastomers Trademark

** DuPont Trademark

*** Monsanto Company Trademark

† 3M Company Trademark

†† Proprietary Garlock material

ООО «ТИ-СИСТЕМС» ИНЖИНИРИНГ И ПОСТАВКА ТЕХНОЛОГИЧЕСКОГО ОБОРУДОВАНИЯ

Интернет: www.tisys.ru www.tisys.kz www.tisys.by www.tesec.ru www.ти-системс.рф

Телефоны: +7 (495) 7774788, 7489626, (925) 5007155, 54, 65 Эл. почта: info@tisys.ru info@tisys.kz info@tisys.by

Installation Instructions

Like any precision-made machine part, a Garlock KLOZURE® Oil Seal should be handled with reasonable care when being installed in your equipment. Although a KLOZURE® Oil Seal is compactly built and is not fragile, rough handling may mar or damage the flexible lip of the sealing member, resulting in an imperfect sealing job.

Assembled and Bonded Seals

Check sizes

Before proceeding with the installation, make sure that the seal of the correct size has been selected and that the surrounding equipment parts are in proper condition. It is suggested, therefore, that the following checks should be made.

1. Is the seal of correct size to fit the shaft? If the shaft is undersize, leakage may follow. If the shaft is over-size, excessive frictional drag may result.
2. Is the bore that is to receive the seal of the proper diameter so that a leakless press fit will be obtained?

Preparation of oil seal

An oil seal does not require any special treatment or conditioning prior to its assembly in the equipment. However, a film or coating of a suitable lubricant makes it easier to apply the seal over the shaft or mounting tool. We recommend lubricating either the shaft or seal lip before mounting seal.

Preparation of shaft

The shaft surface over which the seal will slide must be smooth and free from burrs, nicks or scratches which may damage the sealing lip. Recommended shaft finishes are shown on Table 1, page 14. The free, inside diameter of the lip of a seal is smaller than the diameter of the shaft on which it is used. The end of the shaft should be chamfered or rounded to prevent lip damage and to ease installation of the seal. See Figure 1.

If for any reason the shaft cannot be chamfered or rounded, then a suitable mounting tool should be used for applying the seal. Typical tools for this purpose are shown in Figure 2.

Preparation of housing bore

The bore should be chamfered to permit easy entry of the seal and should have smooth, machined surfaces. Rough surfaces may score the metal case of the seal and permit seepage. See Figure 3, page 21. When a lubricant head is present, if the bore is 100 micrometers AA (2.54 micrometers) or better, bore leakage problems should not be encountered if no tool removal defects are present.

Recommended Shaft Lead Corner

Figure 1

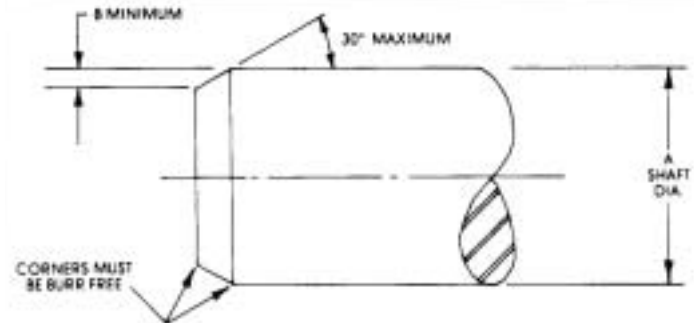

A - Shaft Diameter		B - Minimum*	
Inch	mm	Inch	mm
Thru 0.394	Thru 10.00	0.030	0.75
0.395 - 0.787	10.01 - 20.00	0.040	1.00
0.788 - 1.181	20.01 - 30.00	0.050	1.25
1.182 - 1.575	30.01 - 40.00	0.060	1.50
1.576 - 1.969	40.01 - 50.00	0.070	1.75
1.970 - 2.756	50.01 - 70.00	0.080	2.00
2.757 - 3.740	70.01 - 95.00	0.090	2.25
3.741 - 5.118	95.01 - 130.00	0.110	2.75
5.119 - 9.449	130.01 - 240.00	0.140	3.50
9.450 & Up	240.01 & Up	0.220	5.50

*If a shaft lead-in radius is used, maintain the diametral difference to no less than indicated value

Figure 2

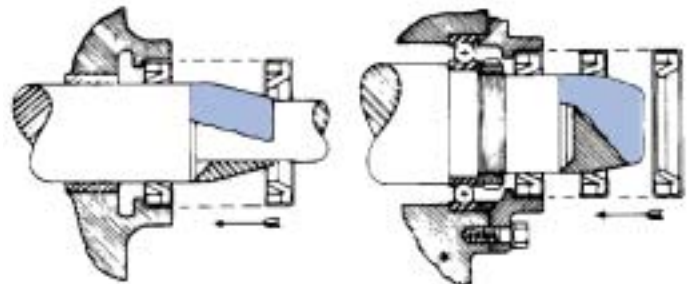

Remove all burrs, break or chamfer all sharp edges. Surfaces over which seal slides must be smooth and free from nicks or rough spots.

Installation Instructions

Figure 3
Housing Bore Dimensions

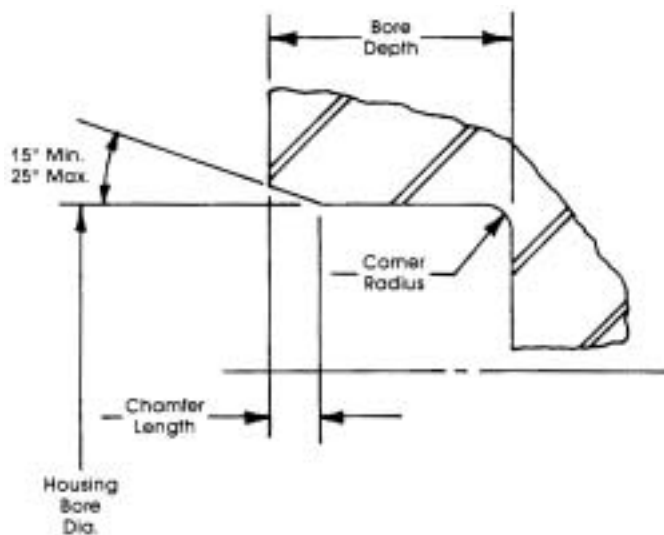

Nominal Seal Width		Chamfer Length		Max. Housing Corner Radius	
Inch	mm	Inch	mm	Inch	mm
Thru 0.394	Thru 10.00	0.03-0.04	0.7-1.0	0.020	0.50
Over 0.394	Over 10	0.05-0.06	1.2-1.5	0.030	0.75

If the surface is rougher than 100 microinches AA (2.54 micrometers) a bore sealer should be used to insure that no outside diameter leakage occurs. If oil seals are purchased without O.D. sealant, a thin coating of shellac or gasket cement may be applied to the inside of the bore recess or outside of the seal case.

If such materials are used, however, care must be taken to make certain that none is spilled on the shaft or on the sealing element.

On grease applications, no bore sealer is required.

Mounting the seal

The preceding recommendations apply to plain shafts. Take additional precautions to prevent sharp edges from damaging the sealing lip when mounting a seal on a shaft having keyways or holes. On these shafts, we recommend a mounting thimble, as shown in Figure 4, page 22. The thimble wall should be as thin as possible to avoid undue distortion of the sealing lip during the mounting operation. On very large shafts, where the use of a thimble may be impractical, brass shim stock with smooth edges may be wrapped around the shaft.

An alternate and less desirable method is to fill the keyway or hole with a smooth wooden plug shaped to protrude slightly

above the surface of the shaft. In an emergency, and if no other means is available, the shaft may be wrapped with a heavy, well-lubricated kraft paper to protect the sealing lip from the shaft irregularities.

Seating the seal

A suitable press is recommended for pressing an oil seal into the bore. The press ram or driving tool should not be more than 0.010" (0.25 mm) smaller in O.D. than the bore diameter and should have a flat face to contact the back of the metal case on the seal. If installing the seal in a reverse position, be sure that the ram pressure is applied only to the rollover bead around the outer diameter of the seal and not to the inside face or filler ring inside the metal outer case.

If a press is unavailable or the use of a press is not feasible, the seal may be seated with a driving plug or tool (see Figure 5, page 22). This tool is placed into position and tapped with a mallet. When large seals are being seated, or in an emergency, a block of wood resting squarely on the seal may be used instead of a driving tool. When seating a seal 20" (508 mm) in diameter or larger the best practice is to drive it simultaneously at opposite points on its circumference. **NEVER HIT THE SEAL DIRECTLY!**

A factor in the functioning of a lip seal is the installed squareness of the seal with respect to the normal shaft centerline. Good general practice is to keep this within 0.010" (0.25 mm) TIR. The proper squareness can be obtained by pressing the seal flush with the front of the bore or bottoming it against a shoulder. The surface a seal is aligned with should always be a machined one. Unfinished surfaces should never be used for alignment purposes because of the danger of cocking the seal. Typical installation tools are shown in Figure 6, page 22.

Some applications require the seal to be pressed into a separate cover plate or bearing retaining ring, with the assembly subsequently mounted over the shaft. On this type of installation, care must be exercised to prevent undue distortion of the sealing member by permitting this heavy assembly to hang on the shaft, supported only by the seal. Designing the cover plate or retaining ring with close tolerances over the shaft helps to relieve the weight on the seal.

If the seal is pressed into a bore or housing before the bearing is installed, it is essential to support the heavy shaft to prevent its weight from damaging the sealing element.

WARNING:

Properties/applications shown throughout this brochure are typical. Your specific application should not be undertaken without independent study and evaluation for suitability. For specific application recommendations consult Garlock. Failure to select the proper sealing products could result in property damage and/or serious personal injury.

Performance data published in this brochure has been developed from field testing, customer field reports and/or in house testing.

While the utmost care has been used in compiling this brochure, we assume no responsibility for errors. Specifications subject to change without notice. This edition cancels all previous issues.

Installation Instructions

Figure 4

A - Ram seated on back of seal

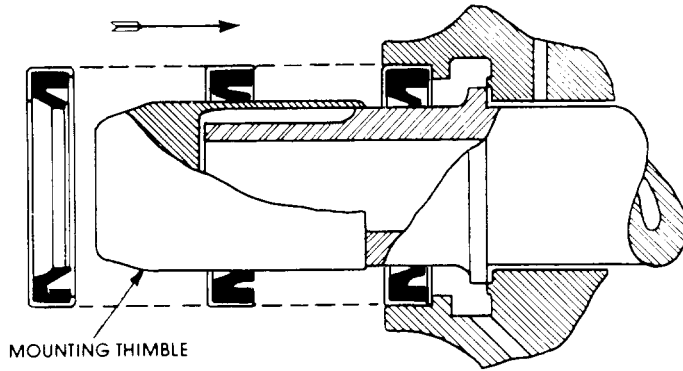
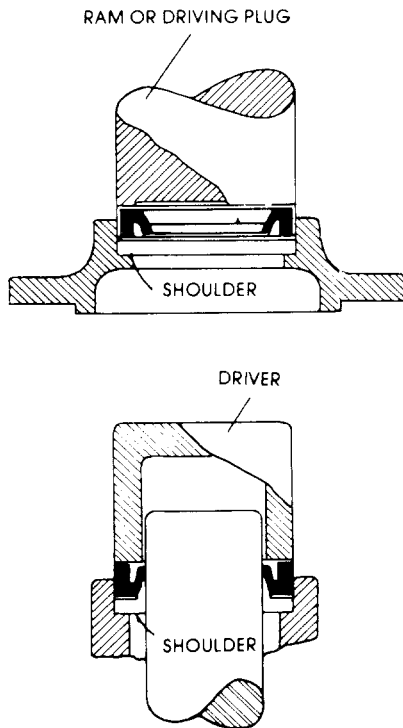

Figure 5

B - Driver seated on roll-over bead of seal



Note: shoulder provides stop and insures mounting seal at right angle to the shaft

WARNING:

Properties/applications shown throughout this brochure are typical. Your specific application should not be undertaken without independent study and evaluation for suitability. For specific application recommendations consult Garlock. Failure to select the proper sealing products could result in property damage and/or serious personal injury.

Performance data published in this brochure has been developed from field testing, customer field reports and/or in house testing.

While the utmost care has been used in compiling this brochure, we assume no responsibility for errors. Specifications subject to change without notice. This edition cancels all previous issues. Subject to change without notice.

Figure 6

A - Through bore: installation tool bottoms on machined bore face

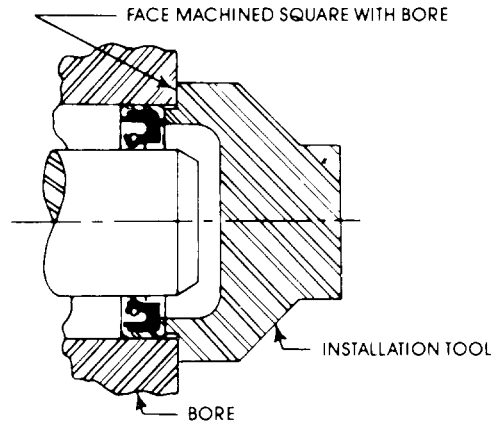

B - Bottom bore: seal bottoms on machine bore shoulder

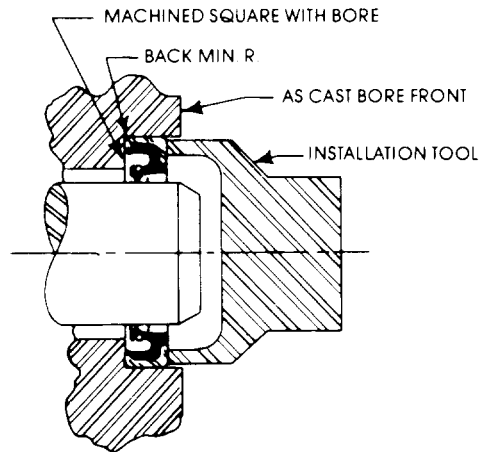

C - Through bore: installation tool bottoms on shaft

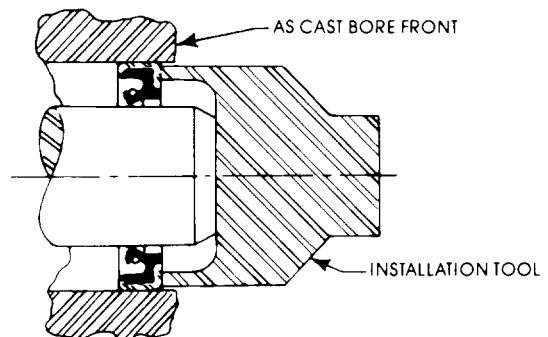

Garlock Split KLOZURE® Oil Seals Models 21, 23, 24, 25 and 26

The Garlock Split KLOZURE® Oil Seal can be split or cut open on the diameter. The seal is installed by placing it around the shaft instead of sliding the seal over the shaft as is necessary with solid seals of the conventional type.

Split KLOZURE® Oil Seals are used on original equipment applications or maintenance applications to replace a conventional oil seal installation when for any reason the renewal of the original seal becomes necessary.

For applications to bearings mounted on shafts carrying couplings, gear, sprockets or flywheels as found on heavy equipment in steel mills, pulp and paper mills and other industries, Split KLOZURE® Oil Seals are particularly suitable as they can be applied without removing or otherwise disturbing those parts.

Contractors' equipment and machines of other types frequently are operated in isolated localities remote from repair and service facilities. On such equipment, the renewal of a conventional oil seal may be an exceedingly difficult, expensive and time-consuming job. A Split KLOZURE® Oil Seal, however, can be installed on the spot easily and quickly by a mechanic or machine operator.

The Split KLOZURE® Oil Seal, because it is not suitable for pressure service, will not work as universally on all applications as the conventional Garlock KLOZURE® Oil Seal. If in doubt as to whether a split or conventional oil seal is more suitable for a specific application, supply your Garlock representative with full details and Garlock will make a recommendation.

Table 6
Model 23 Split KLOZURE® Size Capability

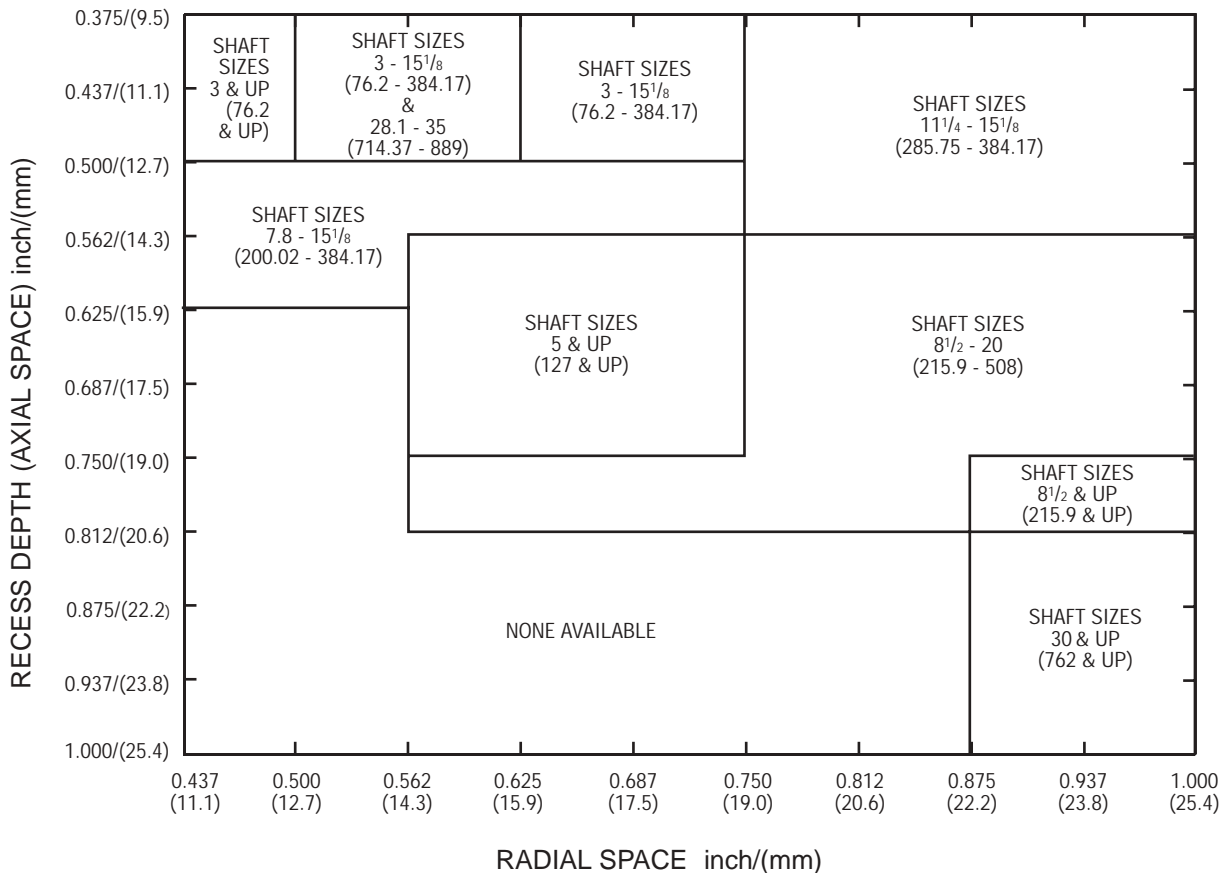

Conversion Instructions - Split Seals

When converting equipment from conventional oil seals to Split KLOZURE® Oil Seals, the following instructions should be followed.

1. Obtain shaft diameters, bore diameter and recess depth dimensions of existing seal or equipment (Figure 12, page 25).
2. Check size listing section (Table 6, page 23) to determine availability of a Split KLOZURE® Oil Seal for the equipment dimension.

Non-stock Split KLOZURE® Oil Seal sizes

Sizes other than those shown in the stock listing can be produced, provided the radial and axial dimensions fall within the limits shown in Table 6, page 23.

To determine the radial and axial dimensions of your application, use the following formula:

$$A. \frac{\text{Bore Diameter} - \text{Shaft Diameter}}{2} = \begin{matrix} \text{Radial} \\ \text{(Packing)} \\ \text{Space} \end{matrix}$$

$$B. \text{Bore Housing Recess Depth} = \text{Axial Space}$$

Example:

Bore Diameter = 11.875" (301.63 mm)

Shaft Diameter = 10.250" (260.35 mm)

Recess (Packing) Depth = 0.750" (19.05 mm)

(Bore Diameter - Shaft Diameter)

$$\frac{11.875" - 10.250"}{2} = \begin{matrix} 0.812" \\ \text{Radial Space} \end{matrix} \quad \begin{matrix} (301.63 \text{ mm}) \\ (260.35 \text{ mm}) \end{matrix}$$

(Recess Depth) 0.750" (19.05 mm) = Axial space

Using Table 6, locate 0.812" (20.62 mm) Radial Space. Move up until the Axial Space of 0.750" (19.05 mm) has been located. Note that this point falls in a box showing shaft size 8-1/2" (215 mm) to 20" (508 mm). Our shaft size in the example is 10.250" (260.35 mm), which falls within the shaft sizes of 8-1/2" (215 mm) to 20" (508 mm), therefore this seal can be produced.

NOTE: In some cases, the radial and axial dimensions fall on lines separating segments of the table. When this occurs, shaft size parameters on either side of the line will apply.

Metric Sizes:

Split KLOZURE® Oil Seals are also available in standard metric dimensions. Price and delivery available on request.

3. Check the equipment operating conditions for shaft speed, runout, temperatures, etc. to verify that they are compatible with a Split KLOZURE® Oil Seal.
4. Proceed with the equipment alterations if necessary to provide space for the Split KLOZURE® Oil Seal selected. The cover plate should also be fabricated.

5. Purchase the Split KLOZURE® Oil Seal required and install as outlined.

Manufacturers of original equipment can supply equipment incorporating a conventional seal but with the ability to convert to a split seal in the field. The following suggestions are of assistance.

- a. Design into the equipment a conventional oil seal with the same shaft, bore and width dimensions as a stock Split KLOZURE® Oil Seal.
- b. Supply the equipment with the cover plate required for the Split KLOZURE® Oil Seal. The end user then can make the conversion from a conventional oil seal to a split seal without any modifications to the equipment.
- c. Maintenance manuals should include information covering the replacement of the conventional seal with a Split KLOZURE® Oil Seal and should list the Split KLOZURE® Oil Seal model number and show installation instructions.

The retaining cover plate, which is made in either a solid ring, two halves, or segments to fit around shafts and bolts or screws, is supplied by the customer and only through special arrangements by Garlock. Such metal parts must be made to meet the requirements of each individual installation.

The shaft, bore and recess depth tolerances shown in Tables 3, 4 (page 15) and 7 (this page) are for the guidance of the designer. When designing equipment on which these seals are to be used, these tolerances should be adhered to. When molding Split KLOZURE® Oil Seals, proper allowance in the radial width of the element is made to insure an interference fit with the shaft. The seal is also made slightly thicker than the recess depth so that when the cover plate is applied, the seal is compressed, preventing leakage and clamping the seal so it cannot rotate with the shaft.

Table 7
Split KLOZURE® Oil Seal Recess Depth Tolerance

Recess Depth		Recommended Tolerance*	
Inch	mm	Inch	mm
Up thru 0.625	Up thru 15.88	±0.002	±0.05
0.626 & Up	15.89 & Up	±0.004	±0.10

*Single seals only. Where application involves two seals, tolerance is to be +0.010"-0.000" (+0.25-0.0 mm).

WARNING:

Properties/applications shown throughout this brochure are typical. Your specific application should not be undertaken without independent study and evaluation for suitability. For specific application recommendations consult Garlock. Failure to select the proper sealing products could result in property damage and/or serious personal injury.

Performance data published in this brochure has been developed from field testing, customer field reports and/or in house testing.

While the utmost care has been used in compiling this brochure, we assume no responsibility for errors. Specifications subject to change without notice. This edition cancels all previous issues. Subject to change without notice.

Installation Instructions for GARLOCK Split KLOZURE® Oil Seals

A Split KLOZURE® Oil Seal should be installed with the split at the top of horizontal mounted shafts. To insure proper application and to prevent damage to the sealing lip of the Split KLOZURE® Oil Seal, the installation should be accomplished as follows:

1. See that the recess is thoroughly cleaned and that all burrs and sharp cutting edges are removed.
2. Apply grease or oil to the shaft.
3. Open Split KLOZURE® Oil Seal joint sideways (as shown in Figure 7) and place it around the shaft at a point near the recess into which the seal is to be installed.
4. Start the sealing element into the recess at the top of the housing by lining up the sealing lip on both sides of the joint as shown in Figure 8. Compress the leading edge of the Split KLOZURE® Oil Seal to enter the housing as shown in Figure 9.
5. Continue this process around the entire periphery of the shaft until the sealing element is inserted in the recess.
6. Seat the seal in the recess as indicated in Figure 10 by tapping the seal lightly with a mallet on a block of wood, using

care to prevent damage to the seal lip. Once seal is seated, approximately 0.015" (0.38 mm) should be protruding from the bore cavity allowing compression of seal as described in paragraph 7.

7. Bolt the cover plate tightly into position to compress the Split KLOZURE® Oil Seal in the recess as shown in Figure 11. Cover plate should be sufficiently heavy to compress the sealing element firmly in recess. Screws or bolts should be as near as possible to the recess bore to prevent cover plate from dishing. Model 26 seals do not require a cover plate.

8. When the Split KLOZURE® Oil Seal replaces the conventional seal, the equipment recess depth may be greater than the thickness of the Split KLOZURE® Oil Seal, thus requiring a filler. Filler gaskets or a split metal washer may be used for this purpose.

9. When a Split KLOZURE® Oil Seal is installed at the end of a plain or sleeve bearing, a drain or vent should enter the space between the seal and the bearing to prevent pressure building up at this point.

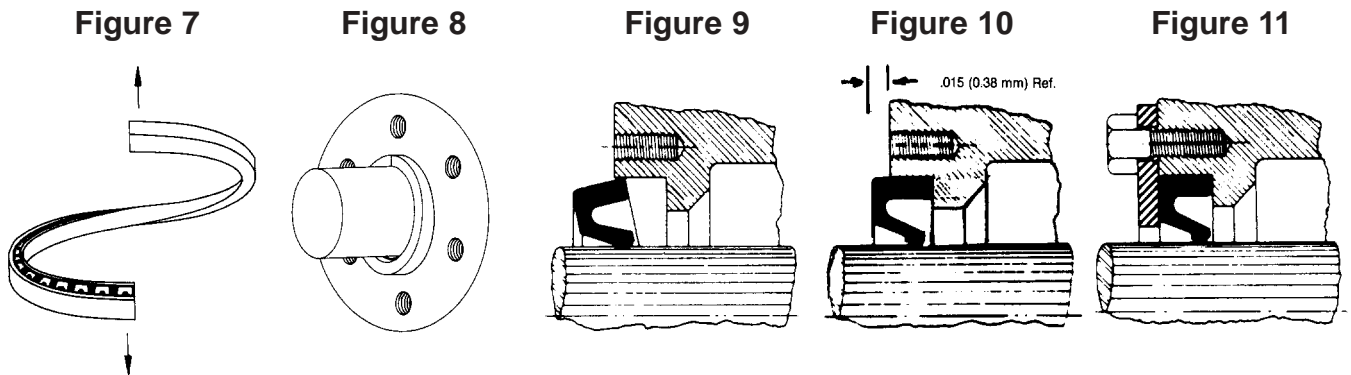

Standard Split-KLOZURE® Oil Seal Installation Figure 12

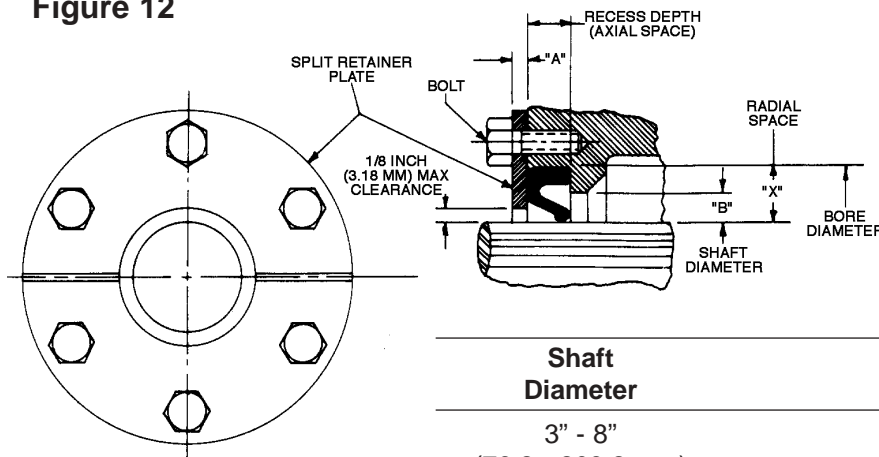

"B" = 0.28 "X" Minimum, 0.5 "X" Maximum

$$"X" = \frac{\text{Bore Dia.} - \text{Shaft Dia.}}{2}$$

Shaft Diameter	No. of Bolts*	"A" Minimum Plate Thickness
3" - 8" (76.2 - 203.2 mm)	6	1/8" (3.18 mm)
over 8" (over 203.2 mm)	Bolts on a max. of 6" (152.4 mm) chord, spacing centered about split in end plate	1/4" (6.35 mm)

*Figures shown are for a guide only. Good machine design practices should be followed.











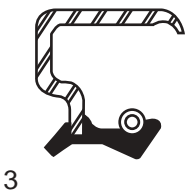
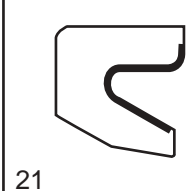

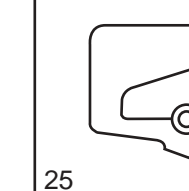
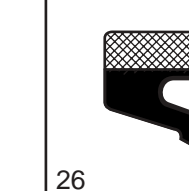
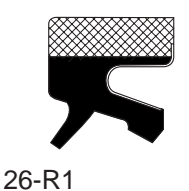
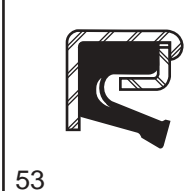
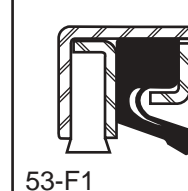
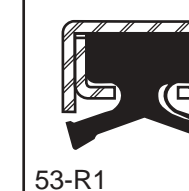
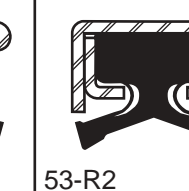
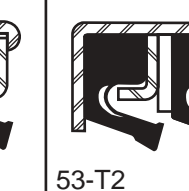

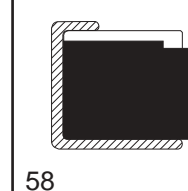
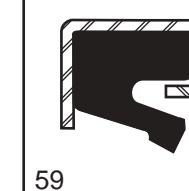
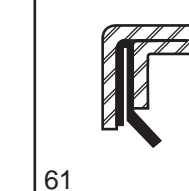
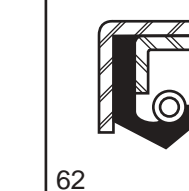

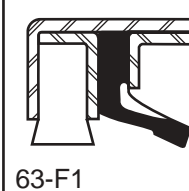
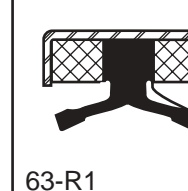
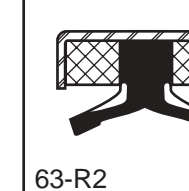
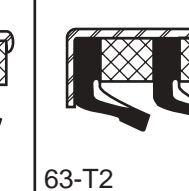
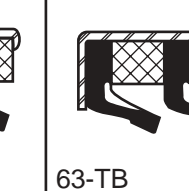

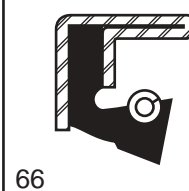
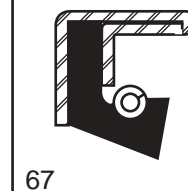
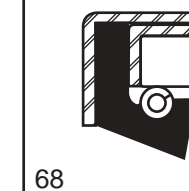
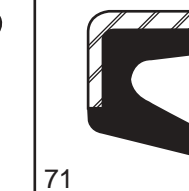
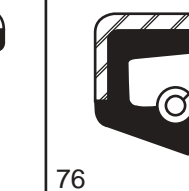
Troubleshooting

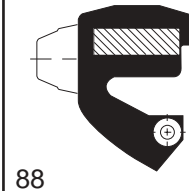
This chart indicates possible sources of seal trouble on general applications. Special installations may require a more complete analysis. If advice or assistance is needed, please contact the nearest Garlock office.

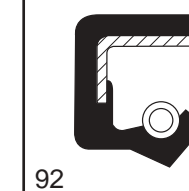
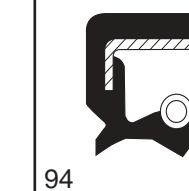
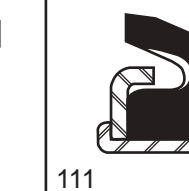
Check for	Possible sources of trouble	Suggested remedy
1. Nicks, cuts or tears in sealing lip	Rough finish on shaft	Finish shaft surface from 10 - 20 microinches. AA (0.25 - 0.50 micrometers). Remove all burrs. See "Preparation of Shaft" page 20.
	Improper installation	Use mounting tool to carry sealing lip over keyways, splines and sharp shoulders. See "Mounting the Seal" page 21.
	Rough handling	Check methods of storing and handling. Seals deserve the same care as the bearings they protect.
2. Excessive wear or hardening of sealing element	Rough finish on shaft	Finish shaft surface from 10 - 20 microinches. AA (0.25 - 0.50 micrometers). See "Preparation of Shaft" page 20.
	Tight fit on shaft	Check service recommendations in catalog to see if correct KLOZURE® Oil Seal model is being used. Check sizes.
	No lubrication	Be sure adequate lubrication is present.
	Overheating	Check size of seal. Check shaft fpm speed with catalog recommendations for model KLOZURE® Oil Seal being used. Check ambient temperatures. Be sure of proper lubrication.
	Pressure	Eliminate pressure by vents or drainbacks. Be sure vents are open. Drainbacks should be provided around bearings or away from helical gearing to prevent pressure buildup at seal face.
3. Damaged spring	Improper installation	Avoid excessive spreading of sealing lip and spring. See "Mounting the Seal" page 21.
	Rough handling	Check methods of storing and handling.
4. Damaged case	Improper driving tools	Use proper tools of correct dimensions. See "Seating the Seal" page 21.
5. Excessive shaft wear	Abrasives	Be sure shaft is clean and that a slight amount of lubricant is applied when installing KLOZURE® Oil Seal.
	Soft Shaft	Use shaft material of Rockwell C 30 minimum hardness.

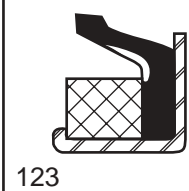
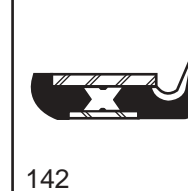
Check for	Possible sources of trouble	Suggested remedy
6. Scores in O.D. of seal	Coarse machining	Give better finish to housing bore. Check for imperfect casting.
	Sharp corners on housing bore	Chamfer housing bore.
	Bore undersize	Check housing bore diameter. See "Tolerances" page 15.
7. Excessive leakage	Light fit on shaft	Check size diameter. See "Tolerances" page 15.
	Abnormal spreading of sealing element	Check service recommendations in catalog to see if correct KLOZURE® Oil Seal is being used. Use mounting tools with thin wall. See "Mounting the Seal" page 21.
	Excessive use of pre-installation lubricant	Do not apply over shaft shoulder more than 1/32" (0.80 mm) larger than shaft diameter. Use only slight amount of lubricant to apply and start seals.
	Presence of lead, helix or spiral from grinding in a direction causing an outward pumping action	Polish shaft with crocus cloth. If possible, alter grinding technique to reduce, eliminate or reverse direction of spirals.
	Cocked seals	Install seal at right angle to shaft surface. Use proper driving tool. Properly prepare housing bore. See "Installation Instructions" page 20.
	Nicks, cuts or tears in sealing lip	See trouble tip number 1.
	Damaged spring	See trouble tip number 3.
	Damaged case	See trouble tip number 4.
	Dynamic runoff	Move seal closer to bearing. Be sure wear sleeves, hubs or retaining rings are accurately machined concentrically. Avoid looseness in splines.
	Paint on shaft at back of seal	Provide suitable masks so that paint will not solidify under sealing element, forcing sealing lip away from shaft.

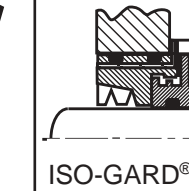
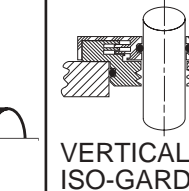
Typical KLOZURE® Oil Seal Configurations

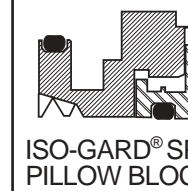
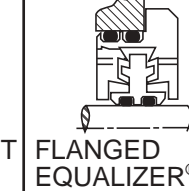
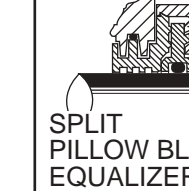
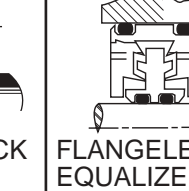
 3	 21	 23	 24	 25	 26
 26-R1	 53	 53-F1	 53-R1	 53-R2	 53-T2
 54	 57	 58	 59	 61	 62
 63	 63-F1	 63-R1	 63-R2	 63-T2	 63-TB
 64	 66	 67	 68	 71	 76
 87	 88	 91	 92	 94	 111
 113	 123	 142	 145	 ISO-GARD®	 VERTICAL ISO-GARD®
 ISO-GARD® GP	 FLANGELESS ISO-GARD®	 ISO-GARD® SPLIT PILLOW BLOCK	 FLANGED EQUALIZER®	 SPLIT PILLOW BLOCK EQUALIZER®	 FLANGELESS EQUALIZER®

WARNING:

Properties/applications shown throughout this brochure are typical. Your specific application should not be undertaken without independent study and evaluation for suitability. For specific application recommendations consult Garlock. Failure to select the proper sealing products could result in property damage and/or serious personal injury.

Performance data published in this brochure has been developed from field testing, customer field reports and/or in house testing.

While the utmost care has been used in compiling this brochure, we assume no responsibility for errors. Specifications subject to change without notice. This edition cancels all previous issues. Subject to change without notice.

ООО «ТИ-СИСТЕМС» ИНЖИНИРИНГ И ПОСТАВКА ТЕХНОЛОГИЧЕСКОГО ОБОРУДОВАНИЯ

Интернет: www.tisys.ru www.tisys.kz www.tisys.by www.tesec.ru www.ти-системс.рф

Телефоны: +7 (495) 7774788, 7489626, (925) 5007155, 54, 65 Эл. почта: info@tisys.ru info@tisys.kz info@tisys.by

Model Number to Part Number Conversion

Garlock

MODEL NO.	PREFIX	MODEL NO.	PREFIX
3	28003	68	21823
21	25001	68R2	23727
23	25003	71	26001
24	25005	76	26193
25	25058		
		87	26080
26	24600	88	26088
26R1	24620	88NS	26188
53	21086	91	27023
53F1	22987	92	27063
53R1	22537		
		94	27223
53R2	22627	111	21011
53T2	22897	113	21012
53TB	22807	123	21016
53TF	22994	142	21432
54	21140		
		145A1	21700
58	21003	145A2	21750
59	24700	EQ	24801
61	24060	EQ	24802
61 FDA	24061	EQ	24807
61 DBL TANDEM	24062		
		EQSPB	24816
61 DBL OPPOSED	24063	IG	29500
61 REVERSE LIP	24064	IG	29502
62	21702	IG	29507
63	21158	IG	29519
63F1	23078		
		IGSPB	29516
63R1	23547		
63R2	23548		
63T2	23550		
63TB	23549		
63TF	23735		
64	21238		
66	21527		
66F1	23692		
66R1	23722		
66R2	23702		
66T2	23728		
66TF	23763		
67	21528		
67R2	23683		
67T2	23621		

Relationship Between RPM, FPM and Shaft Diameters

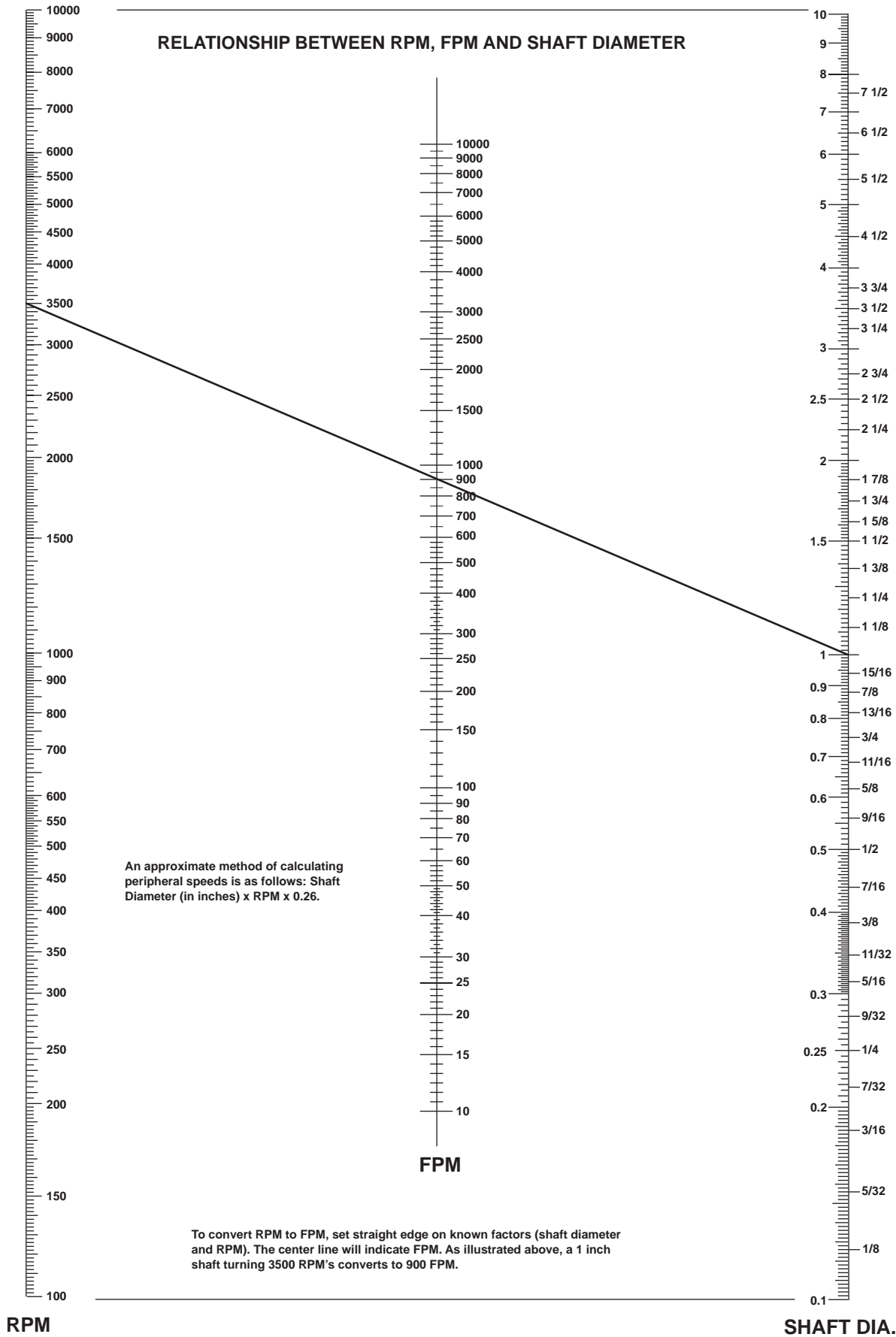

How to Order

Worldwide Garlock KLOZURE® Oil Seal and Bearing Isolator distributors can offer you fast delivery on trouble-free, high-quality oil and grease seals and bearing protectors.

To help maintain maximum sealing effectiveness, we need as much information as possible concerning your operating conditions. The following check list will help you give us the data needed to recommend the proper oil seals for your standard and special sealing requirements.

- Customer name and address
 - Customer's part name and number shown on drawing
 - Description or application of parts
1. **Quantity requirements:** Parts per day, per month, per year; quantity purchased at one time. Will this be a repeat order?
 2. **Packaging requirements (bulk, box, bag, pallet, etc.):** Can customer handle pallets? If not, what is largest carton gross weight customer can handle?
 3. **Material requirements:** Must we meet customer specs? Are they attached? If not, where are they? Element requirement: material, dual lip; case requirement: material, thickness, cover washer.
 4. **Is functional test required?** If yes, describe.
 5. **Suggested design:** By whom, model number, element, case, spring.
 6. **Fixed dimensions:** Shaft, housing bore, recess/width. If still open, indicate.
 7. **Motion: Rotating:** RPM, FPM (MPS), maximum and minimum; reciprocating: stroke, strokes/min.

8. **Shaft:** Material; finish: microinches AA (RMS), finish method; hardness: Brinell, Rockwell C; position: vertical, horizontal.
9. **Housing:** Material, finish, chamfer, shoulder.
10. **Eccentricity:** Bore misalignment, dynamic runout/TIR.
11. **Temperature:** Normal operating, maximum, minimum.
12. **Medium to be sealed:** Inside, pressure, outside, pressure.
13. **Medium level with respect to seal:** Inside, outside.
14. **Assembly:** With or against lip; tool used; splines, keyways, shoulders or other conditions.
15. **Type of bearing:** Location of seal with respect to bearing.
16. **How to specify:** When ordering seals, use model number or computer number. Any special combination should be specified.
17. **Where to order or inquire:** Garlock has established a worldwide network of authorized distributors. Look in the Yellow Pages for the name and the distributor nearest you, or contact:

Garlock Sealing Technologies
1666 Division Street
Palmyra, New York 14522
Telephone: 315-597-4811, 1-800-448-6688